

Installation Instructions

Industrial Heating Cable Products

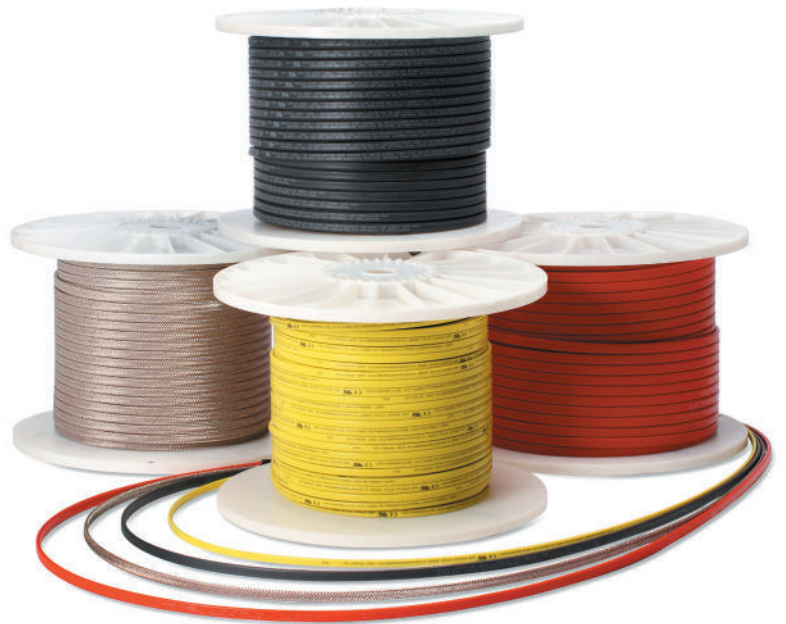

CHROMALOX

Advanced Thermal Technologies

PJ438-26
161-057884-010
May, 2021

Table of Contents

Important Safeguards and Warnings	3
System Components	4
Chromalox Cable Types	5
General Information	6
Use of Manual	6
Storage.....	6
Important Installation Notes	6
Installation	7
Pre-Installation Guidelines	7
Installation Guide: Single Run of Cable.....	8
Installation Guide: Multiple Cable Runs	9
Installation on Fire Protection Systems.....	10
Other Installation Considerations	11
Typical Installation Details	12
Wiring	16
Heating Cable Components	18
Connection Kits.....	18
Accessories	22
Control Systems	23
Controllers	26
Thermal Insulation	28
Commission Testing	28
Specifications	29
Troubleshooting	31
Locating Faults	32
Insulation Resistance (Megger) Test.....	34
Stabilized Current Test	34
End of Current Voltage Test.....	34
Installation and Maintenance Log	35

Important Safeguards and Warnings

⚠ WARNING

FIRE HAZARD. Failure to follow these guidelines could result in property damage or personal injury.

- **Disconnect all power sources before installing or servicing heating cable. Failure to do so could result in personal injury or property damage.**
- **Heating cable must be installed by a qualified person in accordance with the National Electrical Code, NFPA 70.**
- **Each heating cable branch circuit must be effectively grounded in accordance with the National Electrical Code to eliminate shock hazard.**
- **Never attempt to use damaged heating cables or connection kits. If cable damage is observed, either replace the complete heating cable, or cut out the damaged section and replace using the proper splice connection kit. Do not attempt to repair damaged heating cable.**
- **Never energize the cable when it is coiled or on a reel. Test only when it is laid out straight.**
- **Handle coils and reels utilizing equipment designed for that purpose.**
- **Do not drop coils or reels, especially from transporting equipment.**
- **Lift or handle reels so that the lifting/handling device does not come in contact with the cable or it's protective covering. Coils should be placed on a skid.**
- **Handle reels so that the deterioration or physical damage of cable is prevented.**
- **Do not install heating cable on equipment which could become hotter than the heating cable's maximum exposure temperature.**
- **Do not install heating cable in an area or on equipment which contains potentially corrosive materials without having a suitable protective jacket on the cable. Observe all published specifications.**
- **Do not expose cables to temperatures above their specified maximums. Do not run cables longer than specified maximum circuit lengths. See tables provided in this installation manual for details.**

- **Never use tie-wire or pipe straps to secure Self-regulating or Constant Wattage heating cables, as this may damage the cable.**
- **Keep bus wires separated to avoid shorting the cable.**
- **Keep cable ends and connection kits dry before and during installation.**
- **Be careful not to break bus wire strands when preparing the cable, as damaged bus wires can overheat and short.**
- **The presence of heating devices must be evident by the posting of caution signs or markings at appropriate locations and/or at frequent intervals along the circuit.**
- **Users should install adequate controls and safety devices with their electric heating equipment. Where the consequences of failure may be severe, back-up controls are essential. Although the safety of the installation is responsibility of the user, Chromalox will be glad to assist in making equipment recommendations**
- **Insulate the pipe immediately after installing the heating cable, using only fire-resistant insulation materials.**
- **Ground fault equipment protection is required for each circuit**
- **Heating cables require a Class A ground-fault circuit-interrupter and any metallic components in contact with the heating device shall be bonded to ground.**

⚠ CAUTION

A ground fault protection device must be used with this heating device.

⚠ ATTENTION

Ce produit doit être utilisé avec une protection de mise à la terre.

System Components

A complete electric heat trace system includes the following system components – See the figure below for a typical system.

1. Electric Heat Tracing (Self-regulating, Constant Wattage)
2. Termination Accessories
 - A. Power Connection
 - B. Splice/Tee
 - C. End Seal (under insulation, above insulation or signal light type)
 - D. Control Thermostat or RTD Sensor
 - E. Attachments
 - i. Fiberglass tape
 - ii. Aluminum tape for plastic pipe install
 - iii. Pipe clamps for termination accessories
 - iv. Electric Trace Caution Label
3. Controls
 - A. Thermostats
 - B. Digital Thermostats
 - C. Single/Dual Loop Panels
 - D. Weather Trace Panels
 - E. IntelliTrace Panels
4. Thermal Insulation
5. Weather Barrier for Insulation

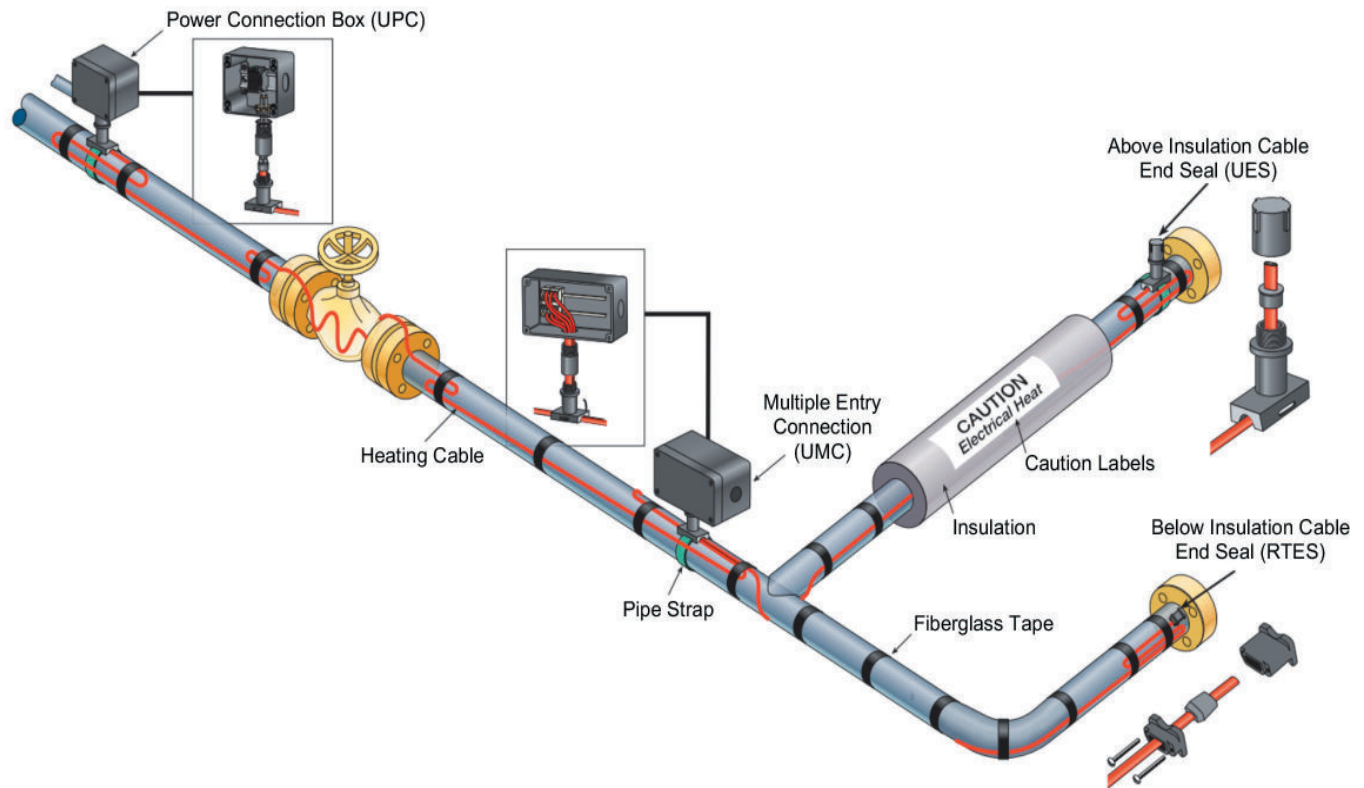

Chromalox Cable Types

Table 1 – Cable Type Overview

	Self-Regulating	Constant Wattage	Mineral Insulated	Series Long Line
Hazardous ratings available	Yes	Yes	Yes	Yes
Usable on plastic pipe	Yes*	No	No	No
Can be cut to length in field	Yes	Yes**	No	Yes
Can be single overlapped	Yes	No	No	No

* SRL only on plastic pipe.

** Must be cut at module point to avoid cold leads.

Table 2 – Maximum Temperatures

Cable Type	Max. Maintain (Power On)	Max. Exposure (Power Off)	Voltage Rating
SRL	150°F	185°F	120, 208-277
SRP	230°F	275°F	120, 208-277
SRM/E	302°F	420°F	120, 208-277
CWM	320°F*	392°F	120, 208-277, 480
SLL	302°F	450°F	120, 208-277, 480, 600
MI	1112°F	1200°F	120-600

* See Table 15 for maximum maintenance temperatures at each output.

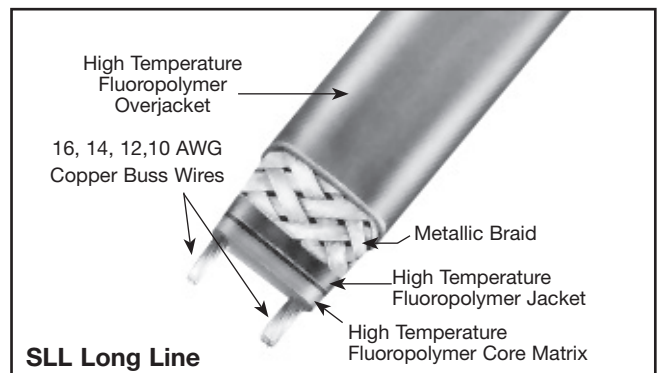
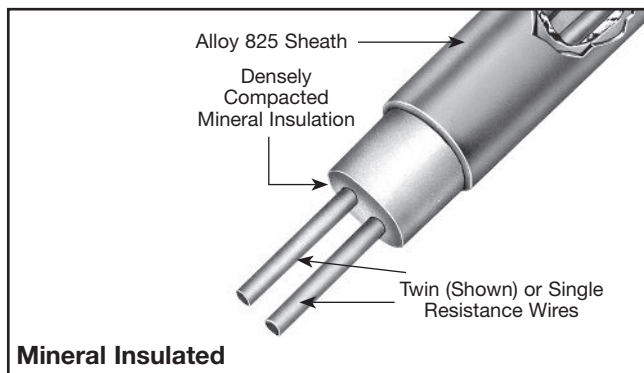
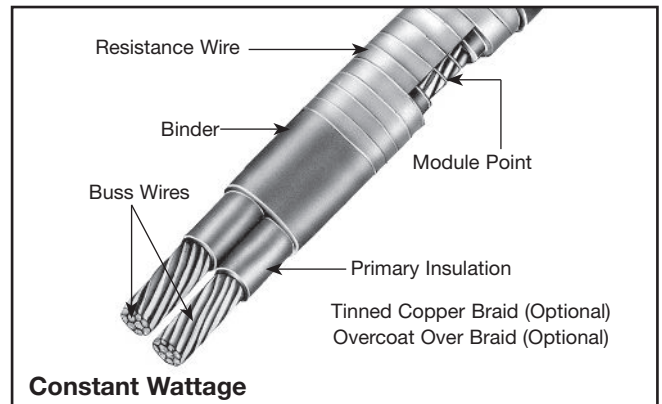
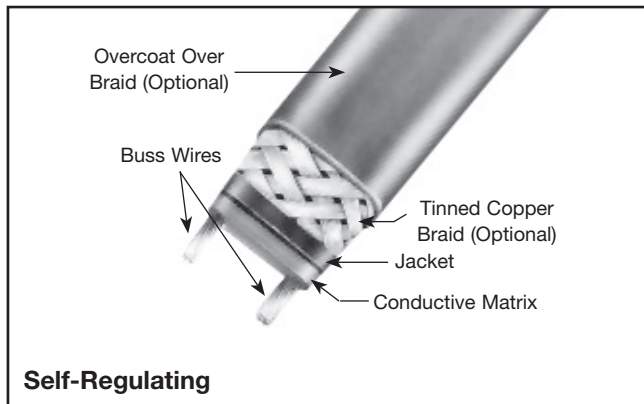

Approvals

Chromalox heating cables and components approved for use in hazardous and nonhazardous locations. Refer to the specific product data sheets for details.

General Information

Use of Manual

These instructions are to be followed when installing Chromalox heating cables on pipes in ordinary locations. Consult factory for installation of braided cable in hazardous locations. This manual discusses the installation of two types of heating cables: parallel cables (SRL, SRP, SRM/E) and series cables (CWM, MI, SLL). Although they are all resistance type cables, they have different operating characteristics. These characteristics may make one type of cable more suitable for a particular application than another. This manual, however, is not intended as a product selection manual. Refer to appropriate application design guide for product selection guidelines. A chart high-lighting certain characteristics for Chromalox heating cables can be found on page 5.

For customer support, design assistance, or information regarding any other Chromalox products, please contact your local Chromalox representative or use the information below.

Chromalox, Inc.
103 Gamma Drive
Pittsburgh, PA 15238
Tel: +1 (412) 967-3800
Fax: +1 (412) 967-5148
Email: is@chromalox.com
www.chromalox.com

Storage

The heating cables should be stored in their shipping cartons or on reels in a dry atmosphere until they are ready to be installed. They should be stored in a clean location, where they are protected from mechanical damage.

Storage temperature range: 0°F(-18°C) to 140°F(60°C).

Important Installation Notes

The following notes should be reviewed prior to installation.

- Always install tracing at the 4 or 8 o'clock position on a pipe.
- Do not attempt to heat trace any piece of equipment which will not be insulated.
- Allow a minimum of 2" between cable runs.
- Always install heat tracing on the outside radius of elbows.
- Never install heat tracing over expansion joints without leaving slack in the cable.
- Pumps and small vessels should be heat traced and controlled with the piping on the inflow end. The cable on the pump or vessel should be physically separate to permit disconnection during maintenance or removal.
- Use aluminum foil tape to cover the heating cable whenever the cable is not in good contact with the pipe (i.e. at supports, valves, pumps, etc.).
- Separately controlled circuits should be provided on dead end legs and closed bypasses.
- No heat tracing circuit should extend more than two feet beyond a point where two or more pipes join when such junctions permit optional flow paths. In such cases, separately controlled traces should be used.
- The minimum installation temperature for all Chromalox heating cables is -76°F (-60°C).
- Chromalox Type SRL heating cables are well suited for heat tracing plastic pipes. Consult "Chromalox Design Guide for Heat Tracing Products" for design recommendations. Installation details apply for plastic pipe only when Type SRL heating cable is used. Consult factory for applications involving other products.
- Always ensure that the heating cable load is compatible with the rating of the selected control systems.
- Only install control devices where the electrical conduit has a low-point drain that prevents condensation from entering the thermostat enclosure.

NOTICE

STORE IN DRY AREA



These products may become damaged by moisture. Damage to electrical components, electrical properties, corrosion or other damage may occur if equipment is not stored in a dry location. Visual inspection and electrical checks must be performed prior to installation to ensure safety and proper operation. See equipment installation manual or contact the factory for more information. 800-443-2640 or www.chromalox.com.

Installation

Pre-Installation Guidelines

Before attempting to install the heating cable, read this instruction sheet and those enclosed with the accessories to familiarize yourself with the products. Complete the following pre-installation steps:

- Verify that the selection of heating cable type and rating is in accordance with the procedures located in the applicable application design guide.
- Ensure that the voltage rating of the heating cable is acceptable for the available service voltage.
- Walk along the pipe segment that is to be traced and plan out the path for the heating cable on the pipe.
- Remove any obstacles or sharp edges that are present along the pipe segment.
- Open package and visually check for breaks or nicks in the cable jacket. File claim with carrier if any damage is found.
- After removing the cable from the carton or wrapping, measure the insulation resistance of the unit from buss wires to braid at 2,500 VDC to assure the cables have not been damaged during shipping and handling. If the cable has no braid, uncoil the cable onto a metal surface and check resistance between the buss wires and the metal surface. See Table 4 for acceptable minimum insulation resistance readings and page 32 for a detailed explanation on how to conduct the insulation resistance test.

⚠ WARNING

ELECTRIC SHOCK HAZARD. Any cable with an insulation resistance reading less than 20 megohms before installation should not be installed. Contact your local Chromalox representative.

- Ensure all pipes, tanks etc. have been hydrostatically tested prior to the installation of the heating cable.
- Ensure all cable ends, connections, and surfaces are dry prior to installation.

⚠ WARNING

ELECTRIC SHOCK HAZARD. Disconnect all power before installing or servicing heating cable. Failure to do so could result in personal injury or property damage. Heaters must be installed by a qualified person in accordance with IEC 62086-2:2001.

Any installation involving electric heating must be effectively grounded in accordance with IEC 62086-2:2001 to eliminate shock hazard.

Installation Guide: Single Run of Cable

If installing a single run of heating cable on a pipe, follow the steps below:

1. Mount the reel of cable on a holder and place near one end of the pipe run to be traced. Choose the end from which it will be the easiest to pay out the cable.
2. Pay out the cable from the reel and loosely string along the piping, making sure the cable is always next to the pipe when crossing obstacles. For example, if the heater is on the wrong side of a crossing pipe, you will have to restring the cable or cut and splice it.

⚠ CAUTION

To prevent damage to cable, avoid such things as:

- **Pulling the cable over sharp edges.**
- **Forcibly pulling the cable free if it snags while being paid out.**
- **Walking on or subjecting the cable to other abuse which could cause mechanical damage.**

3. When you reach the end of the circuit, secure the heating cable to the pipe using glass tape or plastic cable tie with a temperature rating compatible with the heater cable. If this end is to have an end seal installed, remember to leave about a foot of extra cable. If it is a power connection, leave about two feet of extra heater cable.
4. If the heater cable is to be spiraled, go to step 4a. Begin attaching the cable to the pipe about every foot (0.3 meters). Place the cable on the bottom half of the pipe at the 4 or 8 o'clock position. Refer to installation detail AD1. Go to step 5.
 - a. Note the path of the heater cable and the spiral factor of the design. A simple way to think about spiral factor is: A 1.1 spiral factor means install 11 feet of heating cable on every 10 feet of pipe, etc. At about every 10 feet of pipe, pull the required amount of cable and let hang in a loop, and attach the cable to the pipe.
 - b. Rotate the loops around the pipe until all the slack has been taken up. Even out the spirals of the heater cable and secure to the pipe as necessary to obtain good contact. The entire circuit can be installed with hanging loops with the spiraling on the pipe being done when you trace the heat sinks. Refer to installation detail AD3.

5. At a heat sink (pipe supports, valves, pumps, reducers, gauges, bucket strainers, etc.), attach the heater cable to the pipe just before the heat sink. Refer to the design specs or Table 3 to determine the amount of heater cable you need to install on the heat sink. Pull this amount of cable into a loop, attach the heater cable on the other side of the heat sink and continue attaching the cable down the pipe as before.
6. When you reach the heater cable reel, you should have the heater cable attached all along the pipe, with the correct amount of heater cable pulled in loops at all heat sinks. Attach the cable to the pipe, (leave an extra foot if at an end seal, two feet if at a power connection) and cut the heater cable from the reel.
7. Install the heater cable loops on the heat sinks. Refer to the proper installation detail AD5-AD12 for a general idea of how to install the cable, but remember:
 - It is important to get the proper amount of heater cable on the heat sink, rather than exactly as the detail shows. The detail is just a guide.
 - Self-regulating heater cables are very flexible and can be single overlapped for installation ease. Feel free to use this feature when you can.
 - By having the cable installed this way, it can be removed easily from the heat sink without cutting of access to, or removal of the heat sink is required.

Note: If a tee is designed into the system, or if you are using two or more short cable lengths to complete a circuit, allow two or three feet of each cable to overlap. This will allow flexibility in assembling the connection kit and locating it on the pipe.

⚠ WARNING

FIRE HAZARD. Do not overlap constant wattage heating cables.

Installation Guide: Multiple Cable Runs

There are two cases where you will need to install more than one heater cable on a pipe:

- When the design calls for more than one cable.
- When the lines being heat traced are considered important enough to install a backup (redundant) heat tracing system.

The installation requirements are different for these cases.

Installing Multiple Heater Cables for Design Requirement

The most common multiple cable requirement is two cables on a pipe. Below are the recommended techniques for the two cable systems. They also apply to installations where three or more cables are to be installed on a pipe.

There are two ways of paying out two heater cables along a pipe. The first is to locate two reels of heater cable and supply one cable from each. This method works for all types of piping runs. However, it may increase material waste by leaving unusable lengths from two reels. The second way is to supply both cables from one reel. This method is generally the easiest for relatively straight, simple piping runs. For each circuit, decide which method to use and then go to the appropriate part below.

1. Supplying cable from two reels

The general procedure here is the same as given earlier, but there are a few things to do to make sure the system is correctly done.

- a. At each heat sink, the easiest thing to do is supply the extra heater called for by the design drawing from only one heater cable. This avoids having to measure out half of the requirement from each cable.
- b. When doing the previous step, leave a small loop in the other cable at equipment which may be serviced, such as pumps, valves, instruments, etc. This is so both heater cables may be removed enough for future access.

2. Supplying cable from one reel

The general procedure is the same as given earlier, but there are a few things to do to make sure the system is correctly done.

- a. With this method, a loop is pulled for the entire circuit. To do this, attach the end of the heater cable to the pipe near the heater cable reel. Remember to leave enough extra cable for the type of connection to be installed.

- b. Begin pulling the cable off the reel in a large loop down the piping run. Be sure to keep the cable next to the pipe. Moving down the run, continue attaching the cable to the pipe, leaving the side of the loop going back to the reel unattached.
- c. You will want both sides of the loop to be about the same length to avoid future problems. Also, it is easier to install the extra cable required at each heat sink from only one cable. Therefore, pull the right amount of extra heater cable needed at every second heat sink from the side of the loop you are attaching to the pipe. At the remaining serviceable heat sinks (pumps, valves, instruments, etc.) do not forget to leave a short loop of cable for slack when access to the equipment is needed.
- d. When the end of the piping run is reached, pull the proper amount of extra cable for the connection to be installed.
- e. Now, begin working the remaining side of the loop back toward the reel, installing it on the pipe and heat sinks as required.

Installing Backup (Redundant) Systems

The purpose of a backup system is to provide the proper amount of heat from the second heater cable if there are problems with the first. Therefore, each cable must be installed so it can do the job alone. The simplest way to do this is to install the first heater cable as described in the Installation Guide: Single Run of Cable section. Then, go back and install the backup heater cable the same way.

There are several things to keep in mind:

- The power connections and end seals for the two cables are often designed to be at opposite ends of the run in a redundant system. Remember to leave the proper amount of extra cable for the connection to be installed on each cable at that end.
- On piping one inch IPS or smaller, it can be difficult to apply both heater cables with good contact at all places. The main thing is to get the correct amount of cable installed. However, try to get as much contact with the piping and heat sinks from both cables as possible.

Supplementary Instructions: ATEX and IECEx Applications

SRL and SRM/E Self-Regulating Heating Cables, U Series Connection Accessories Type DTS-HAZ, UPC, UMC, UES and RTES

- Do not bend the cable for a length of 300mm from the cable gland inlet.
- Connection and termination of Chromalox ATEX and IECEx certified cable must be carried out by using the U Series of certified cable connection kits as supplied by Chromalox, Inc. These are only to be used for the operations for which they were designed.
- The supply circuit to the heating cables must be protected by a safety differential device or equivalent ground fault protection.
- The earthing braid of the heat trace cable must be bonded to a suitable earth terminal.
- The minimum cable installation temperature for SRL and SRM/E cable is -40°C (-40°F).
- The certified minimum cable exposure temperature for SRL and SRM/E cable is -60°C (-76°F).

Other Installation Considerations

Pipe Hanger

When using a pipe hanger, ensure that the heating cable is not pinched between the pipe and the hanger. Damage to the cable can result in electrical arcing, arc faults, and arc flashes.

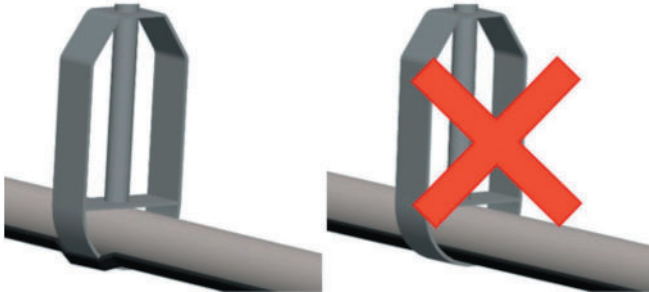

Slab Penetrations

Before installing heating cables on a pipe that penetrates a concrete floor or wall, be sure that the hole comfortably fits both the pipe, cable, and insulation. Do not damage or cut the heating cable during installation. Make sure that the cable is not pinched between the pipe and the concrete floor and wall when the hole is sealed. When fire stopping around floor and wall penetrations, avoid damaging or cutting the heating cable. The heating cable should be protected by a tube or conduit and should not be installed directly into the sealing material.

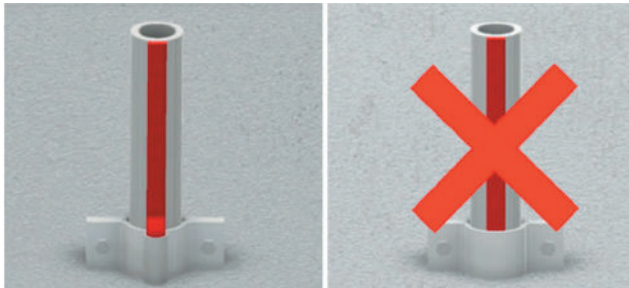

Bending the Heating Cable

Do not attempt to bend the heating cable in the flat plane, as it may be damaged. The minimum bending radius for all Chromalox heating cables is six times the minor diameter.



Heat Sinks

Refer to the design specs or Table 3 to determine the amount of heater cable you need to install on each heat sink. Install the heater cable on the heat sinks as explained in installation details AD5-AD12. However, remember that the detail is just a guide. It is important to get the proper amount of heater cable on the heat sink, rather than exactly as the detail shows.

Table 3 – Additional Cable Lengths Required for In-Line Components (Based on Iron Pipe Size)

Piping Size	Gate Valve	Globe Valve	Ball Valve	Butterfly Valve	Shoe Support	Hanger Support	Sleeper Support	Flange Pair
Dimensions in Feet (Ft.)								
1/2 in.	1.00	1.00	1.00	1.00	1.00	1.00	1.00	0.30
3/4 in.	1.50	1.00	1.00	1.00	1.50	1.00	1.00	0.30
1 in.	2.00	1.00	1.00	1.00	1.50	1.00	1.00	0.30
1-1/2 in.	2.50	1.50	1.50	1.50	2.00	2.00	2.00	0.30
2 in.	2.50	2.00	2.00	2.00	2.00	2.00	2.00	0.30
2-1/2 in.	2.50	2.00	2.00	2.00	2.00	2.00	2.00	0.30
3 in.	3.00	2.50	2.50	2.50	2.00	2.00	2.00	0.50
4 in.	4.00	3.00	3.00	3.00	2.50	2.50	2.50	0.50
6 in.	5.00	3.50	3.50	3.50	2.50	2.50	2.50	0.80
8 in.	7.00	4.00	4.00	4.00	2.50	2.50	2.50	0.80
10 in.	8.00	4.50	4.50	4.50	3.00	3.00	3.00	0.80
12 in.	9.00	5.00	5.00	5.00	3.00	3.00	3.00	0.80
14 in.	10.00	5.50	5.50	5.50	3.00	3.00	3.00	1.00
16 in.	11.00	6.00	6.00	6.00	3.50	3.50	3.50	1.00
18 in.	12.00	7.00	7.00	7.00	3.50	3.50	3.50	1.00
20 in.	13.00	7.50	7.50	7.50	3.50	3.50	3.50	1.00
22 in.	13.00	7.50	7.50	7.50	3.50	3.50	3.50	1.00
24 in.	15.00	8.00	8.00	8.00	4.00	4.00	4.00	1.00

Typical Installation Detail

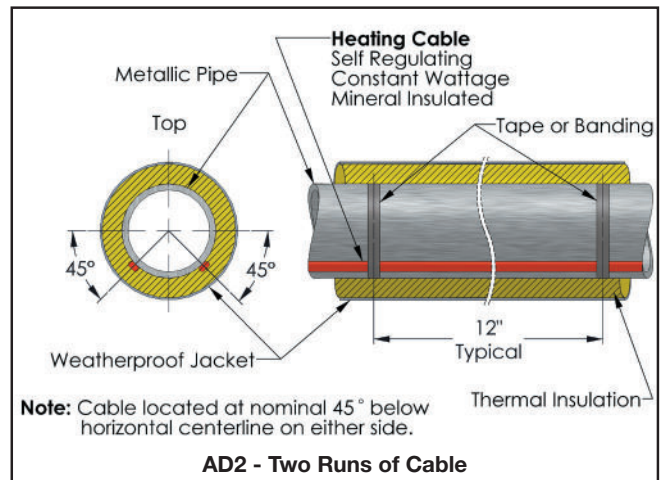
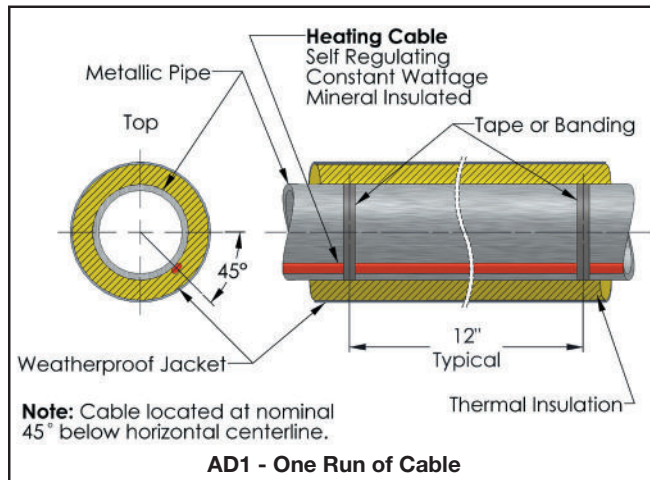

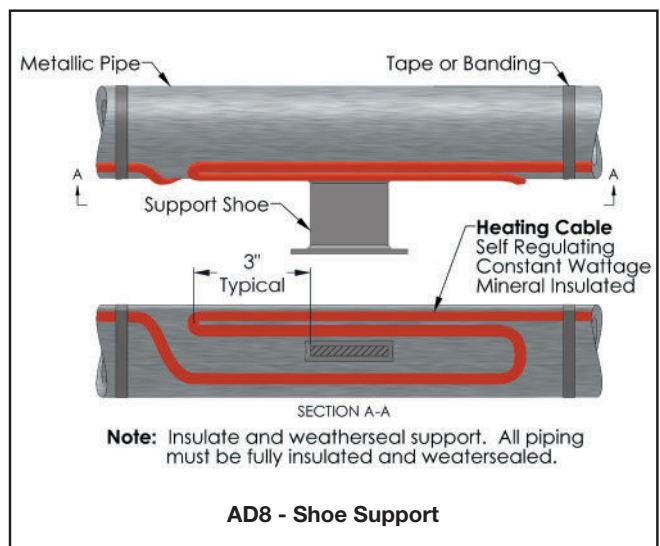
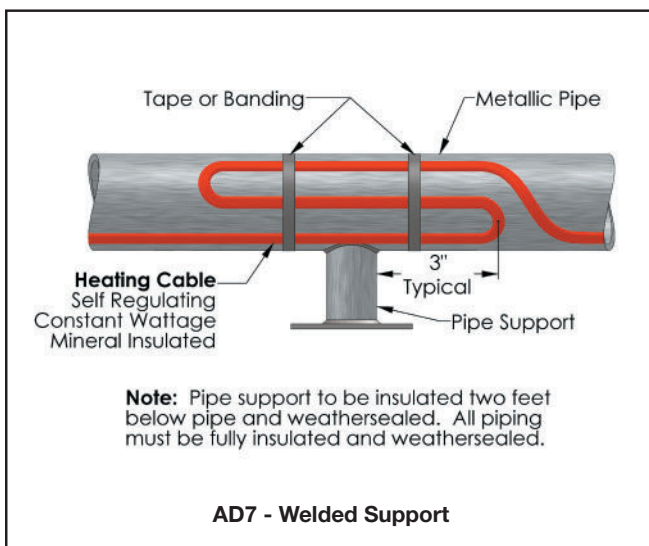
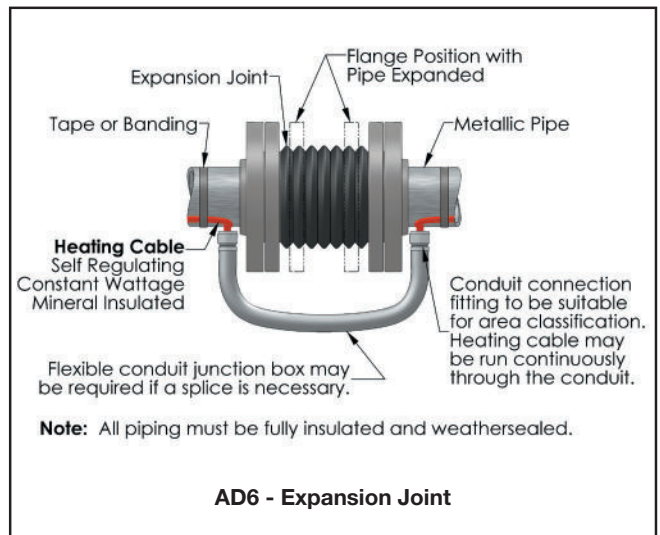
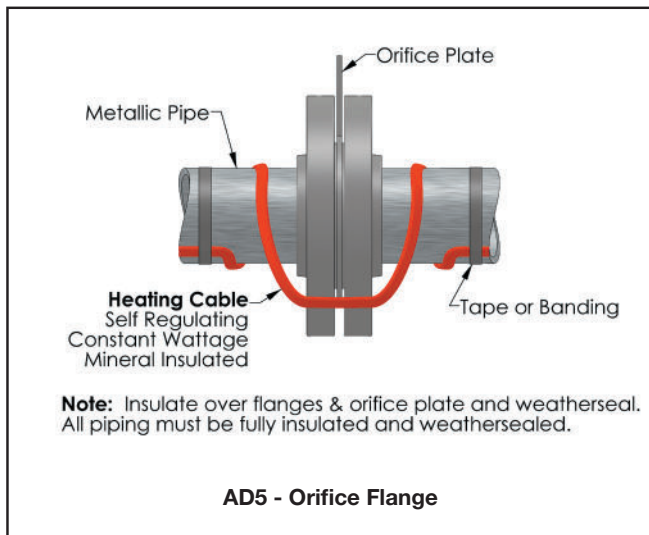
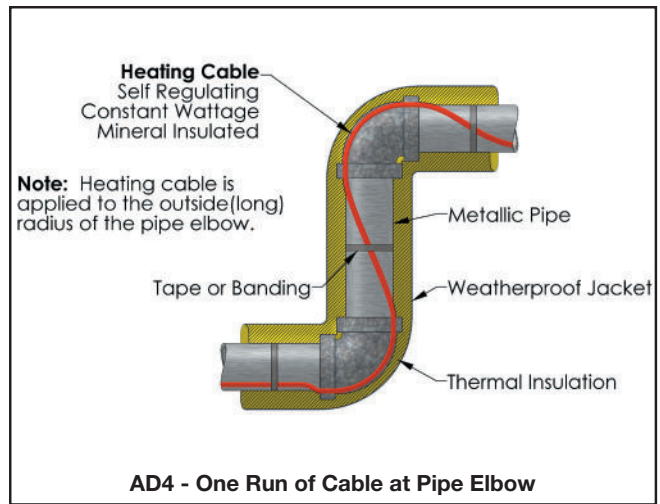
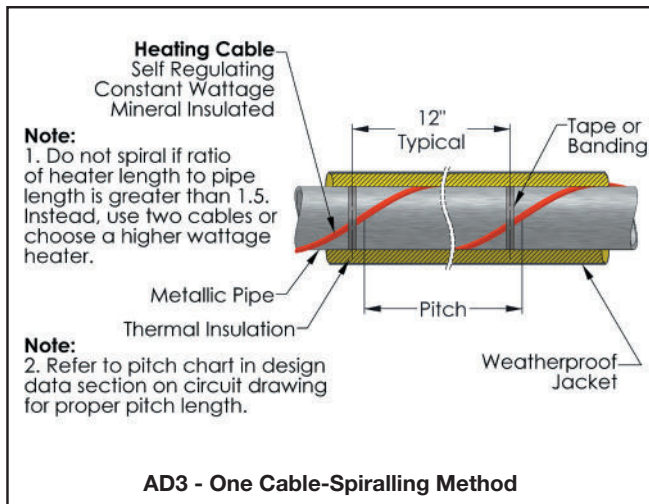

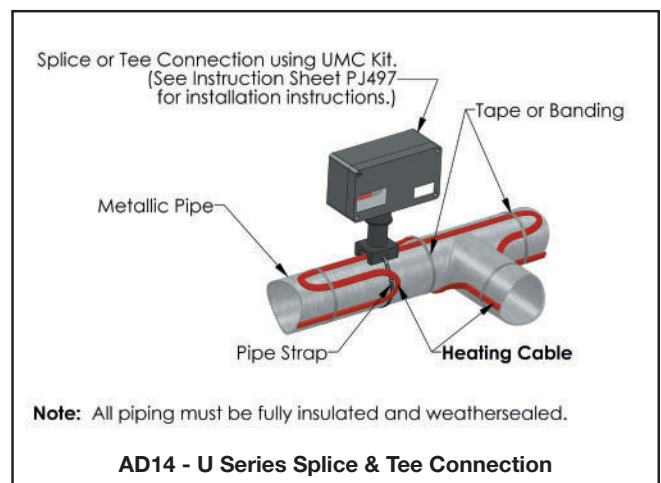
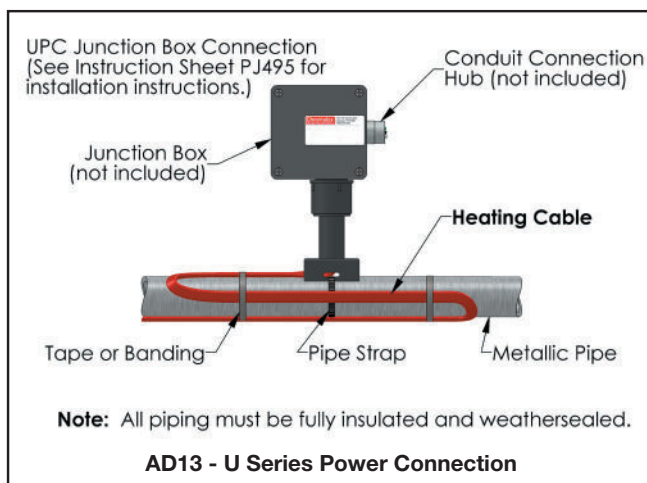
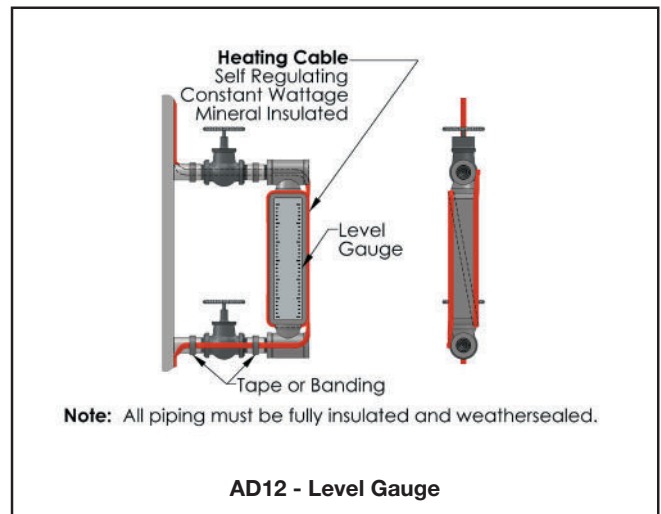
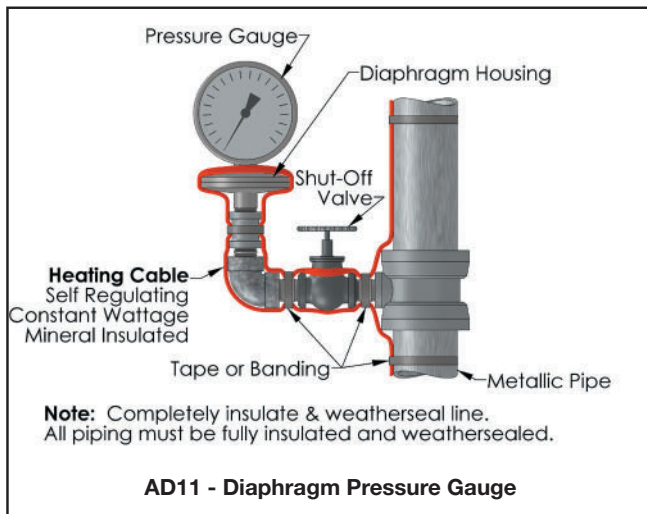
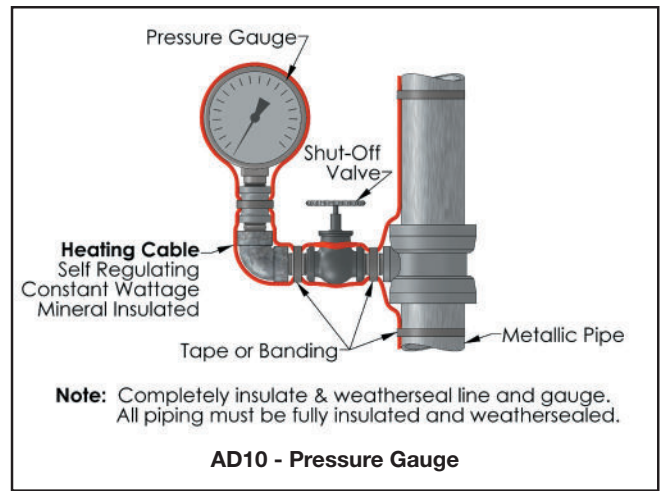
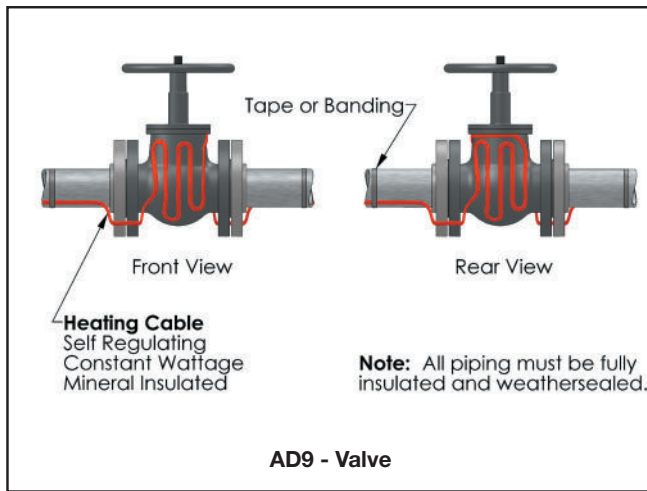

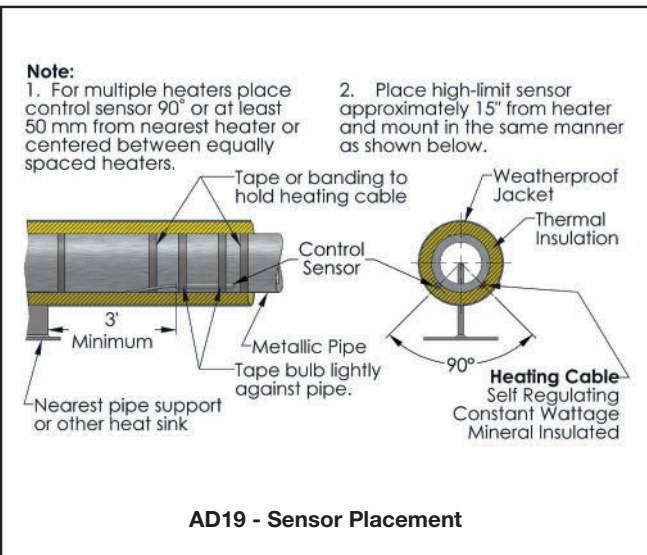
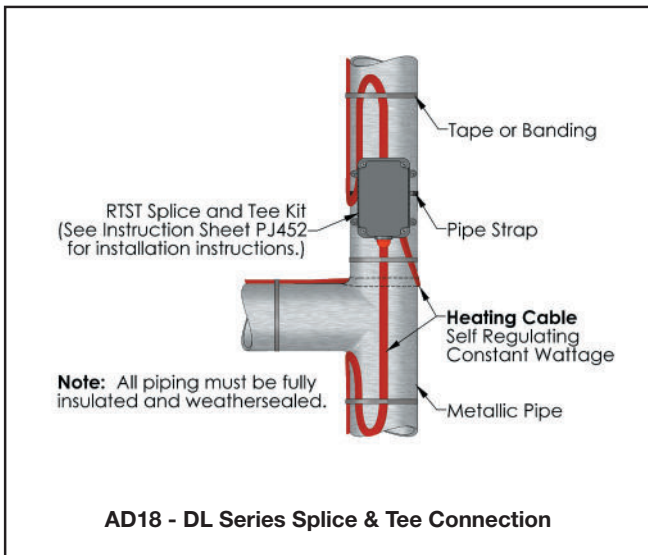
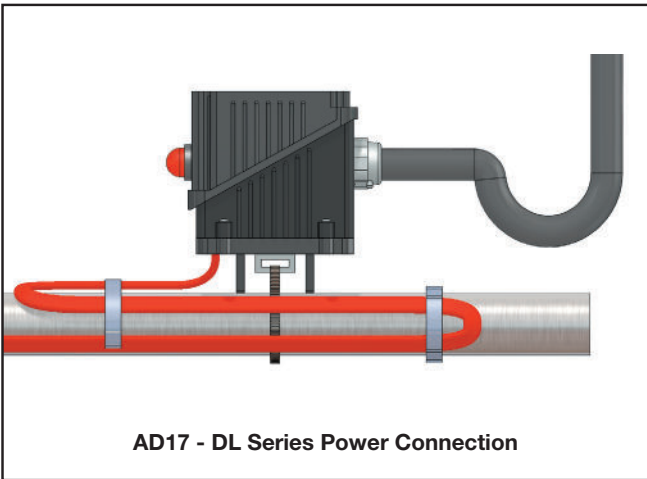
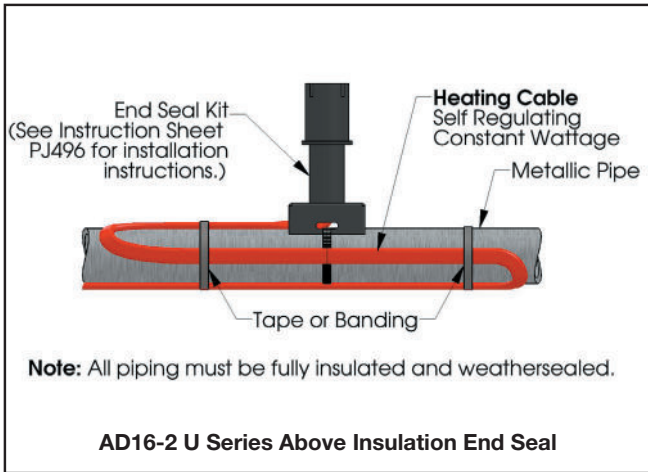
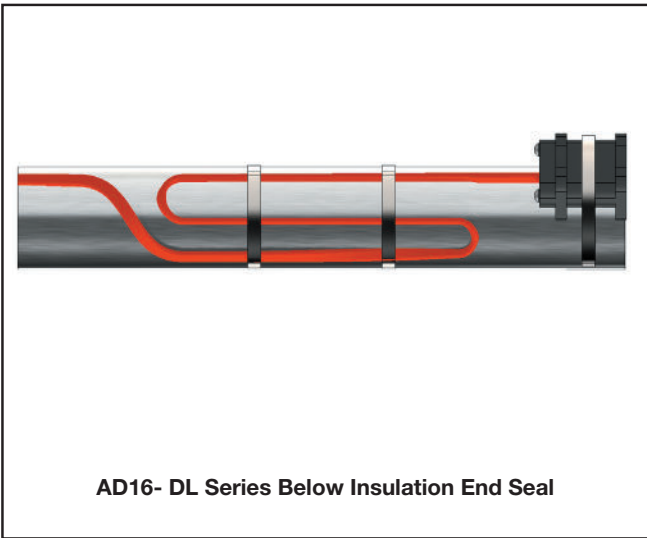
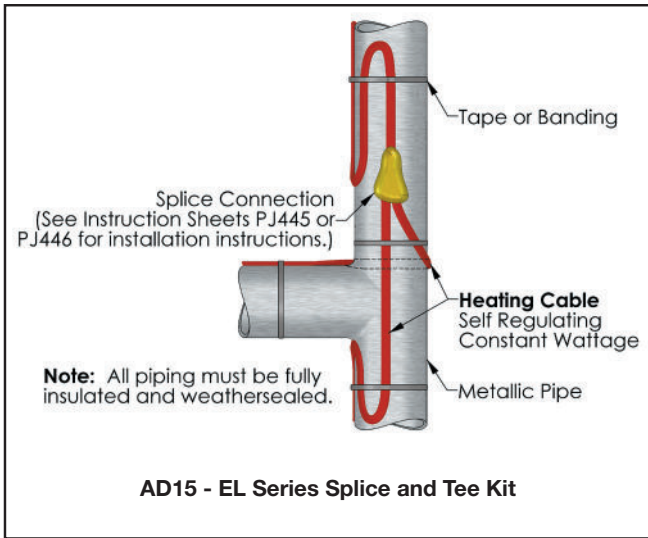

Wiring

⚠ WARNING

ELECTRIC SHOCK HAZARD. Disconnect all power before installing or servicing heating cable. Failure to do so could result in personal injury or property damage. Heater must be installed by a qualified person in accordance with the National Electrical Code, NFPA 70.

⚠ WARNING

ELECTRIC SHOCK HAZARD. Any installation involving electric heating cables must be performed by a qualified person and must be effectively grounded in accordance with the National Electrical Code to eliminate shock hazard.

ACCESSORIES:

- Selection of installation accessories should be in accordance with ChromaTrace 4 design software program. Ensure accessories are rated for the area where they are located. If Chromalox accessories are not used with cable, all third-party approvals are voided.
- Only use Chromalox installation kits and use them only for the operations for which they are designed.
- The instructions included in the Chromalox installation accessories must be followed for the third-party approvals (UL, FM, CSA, ATEX, IECEx, etc.) to apply.
- Junction boxes must be in accordance with the requirements of the area classification.
- All outdoor junction boxes must be located above grade level. Covers should be kept on the boxes at all time when not being worked in.
- All terminations must be protected from the weather and from physical damage by locating them either under the weather-proof insulation or inside an appropriate junction box.
- All equipment must be properly grounded.

- Install installation accessories according to the instructions included in the kits and per installation details AD13 through AD19.

⚠ CAUTION

To prevent equipment damage, Circuits fed from overhead lines should be protected by secondary lighting arrestors.

CONTROLS:

- All heating circuits should have temperature controls. Temperature control of the pipeline can be obtained through various Chromalox temperature controls.
- Contactors must be used when load currents exceed the rating of the thermostat contacts. Equipment protection ground fault (30 mA EPD) thermal breakers are recommended with types SRL, SRP, SRM/E, SLL, and CWM.
- The temperature control should be mounted in a location where it will not be subjected to excessive shock or vibration.
- Line sensing temperature sensors should be mounted in accordance with installation detail AD19.
- Ambient sensing temperature sensors should be located at a point where the lowest ambient temperature is expected.

⚠ CAUTION

To prevent equipment damage, handle and secure temperature sensors, especially thermostat bulbs and capillaries with care to avoid distortion or crimping which might impair control accuracy.

- Exposed thermostat capillaries should have mechanical protection.

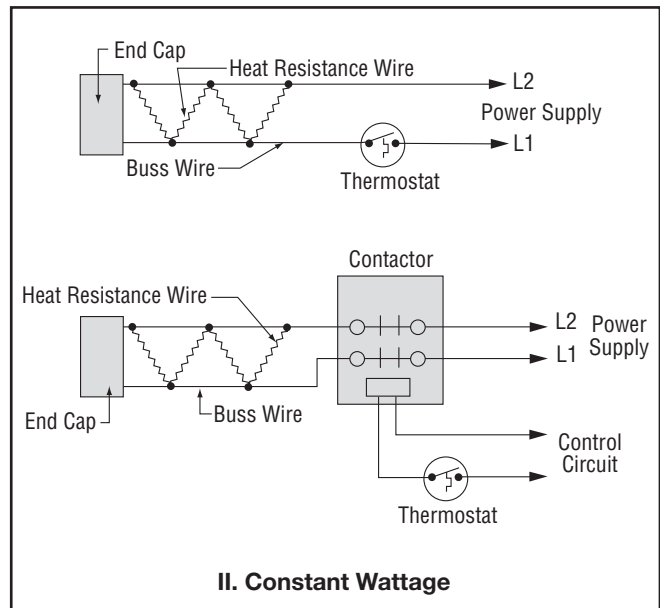
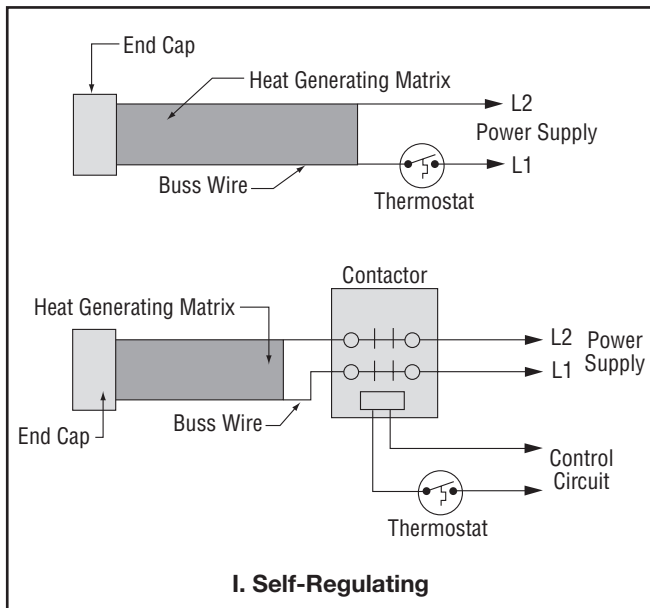

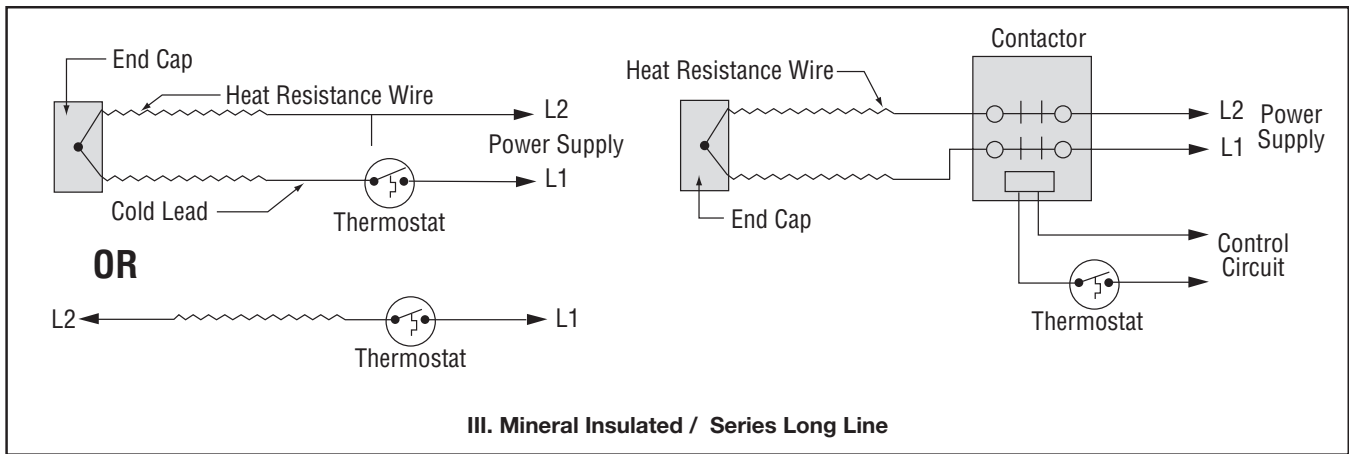

Installation Testing

To identify potential damage, installation testing should be completed at the following times:

- Prior to installing the heating cable
- Prior to installing the connection kits
- Prior to insulating the pipe
- After insulating the pipe
- Prior to energizing the cable
- During periodic system check-ups
- After maintenance/repair work

As part of the installation testing, complete the following steps:

1. Visually inspect the heater cable and temperature controls for signs of mechanical damage. If damage is seen, either replace the complete heater cable, or cut out the damaged section and replace using the proper splice connection for the area and cable you are using.
2. Inspect all connections to be sure they are correctly assembled. Be sure each heater cable entry to a connection has a grommet and the compression plates and caps are properly tightened.
3. Determine the insulation resistance of the circuit using at least 1,000 VDC. It is strongly recommended that higher test voltages be used. Polymeric cables (SR, SLL, and CWM) should be tested at 2,500 VDC. Always perform this test at the power connection. See Table 4 for minimum insulation resistance readings. Any cable with an insulation resistance below the recommended value should be removed and factory should be contacted. See page 31 for a detailed explanation on how to conduct the insulation resistance test.
4. Check voltage at the end of circuit and record in the log on page 33. See page 31 for information on how to complete the end of circuit voltage test.

Table 4 – Minimum Insulation Resistance Readings

	Delivery	Installation Pre-Insulation	Installation Post-Insulation	Maintenance
Chromalox SRL	20 MΩ	20 MΩ	5 MΩ	5 MΩ
Chromalox SRP	20 MΩ	20 MΩ	5 MΩ	5 MΩ
Chromalox SRM/E	20 MΩ	20 MΩ	5 MΩ	5 MΩ
Chromalox CWM	20 MΩ	20 MΩ	5 MΩ	5 MΩ
Chromalox MI	20 MΩ	20 MΩ	5 MΩ	5 MΩ
Chromalox SLL	20 MΩ	20 MΩ	5 MΩ	5 MΩ

Heating Cable Components

Connection Kits

Table 5 – U Series Connection Kits Overview







	Catalog Number	Description	Installation Manual
	<p>UPC Power Connection Box</p>	<p>NEMA 4X rated junction box designed to connect cables to customer supplied power wiring. This kit provides water-resistant cable entry for one cable, enclosure support, terminal block, and a water-resistant corrosion-resistant wiring enclosure with a 3/4" opening to accept a conduit hub (CCH-2 or equal)</p>	<p>PJ495</p>
	<p>UMC Multiple Entry Power Connection Box</p>	<p>NEMA 4X rated junction box designed to connect two or three cables. This kit provides water-resistant cable entry, enclosure support, terminal block, and a water-resistant, corrosion-resistant wiring enclosure. In addition to splicing or teeing cables, this model can be used to provide power connection to up to three cables from one connection kit.</p>	<p>PJ497</p>
	<p>UES Above Insulation End Seal Kit</p>	<p>NEMA 4X rated end seal designed to terminate cables. This kit provides water-resistant cable entry for one cable. It has a corrosion-resistant pipe support that brings the cable end outside of the insulation for easy access.</p>	<p>PJ496</p>
	<p>UESL End Seal Signal Light Kit</p>	<p>NEMA 4X rated end seal designed to seal one cable and indicate power on with universal voltage 120-277 LED indicator light. This model provides water-resistant cable entry, enclosure support, terminal block, and corrosion-resistant wiring enclosure. Available in red and green.</p>	<p>PJ448</p>
	<p>USL Power/End Seal Signal Light Kit</p>	<p>NEMA 4X rated end seal designed to power or seal one cable and indicate power on with universal voltage 120-277 LED indicator light. This model provides water-resistant cable entry, enclosure support, terminal block, and corrosion-resistant wiring enclosure.</p>	<p>PJ937</p>
	<p>SSK Single Entry Sealing Kit</p>	<p>This kit provides water-resistant cable entry for one cable. It has a corrosion-resistant pipe support that brings the cable end outside of the insulation for easy connection to power.</p>	<p>PJ498</p>

Table 6 – U Long Line Series Connection Kits Overview



	Catalog Number	Description	Installation Manual
	UPC LL Power Connection Kit	NEMA 4X rated junction box designed to connect SLL heating cables to customer supplied power wiring. This kit provides water-resistant cable entry for one cable, enclosure support, crimp connections, cold leads, and a water-resistant corrosion-resistant wiring enclosure with an opening to accept a 3/4" conduit hub.	PJ951
	UMC LL Multiple Entry Power Connection Box	NEMA 4X rated junction box designed to connect two SLL heating cables to each other. This kit provides water-resistant cable entry for one cable, enclosure support, crimp connections, and a water resistant corrosion-resistant wiring enclosure with an opening to accept a 3/4" conduit hub.	PJ949
	UES LL End Seal Connection Kit	NEMA 4X rated junction box designed to terminate SLL heating cables outside of the insulation. This kit provides water-resistant cable entry for one cable, enclosure support, crimp connections, and a water-resistant corrosion resistant wiring enclosure with an opening to accept a 3/4" conduit hub.	PJ950

Table 7 – DL Series Connection Kits Overview

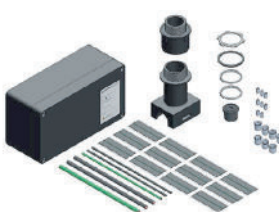
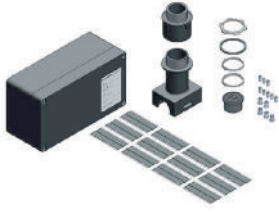

	Catalog Number	Description	Installation Manual
	RTES End Seal Kit	NEMA 4X rated enclosure that provides waterproof cable entry for one (1) cable. The fitting has two (2) different mounting surfaces: one for pipes with a diameter of 3" or more, and one for smaller pipes	PJ450
	RTPC Power Connection Kit	NEMA 4X rated junction box that provides waterproof cable entry for up to three (3) cables with an opening to accept a 3/4" conduit hub (Chromalox CCH-2 or equal).	PJ451
	RTST Slice & Tee Kit	NEMA 4X rated junction box that provides waterproof cable entry for two (2) cables for a splice or three (3) cables for a tee.	PJ452

Table 8 – HL Series Connection Kit Overview











	Catalog Number	Description	Installation Manual
	<p>HL-PC Power Connection Box for Hazardous Locations</p>	<p>Division 1 certified junction box and seal fitting. The kit is designed to connect self-regulating cables to customer supplied power wiring. The pipe stand-off and seal fitting combination provides a water resistant and explosion proof seal. The junction box has a 3/4" opening with top or side entry for the power connection.</p>	<p>PJ912</p>
	<p>HL-S Splice Kit for Hazardous Locations</p>	<p>Division 1 certified junction box and seal fittings. The kit is designed to splice two self-regulating cables. The cable entry fitting and seal fitting combination provides a water-resistant and explosion proof seal.</p>	<p>PJ920</p>
	<p>HL-T Tee Kit for Hazardous Locations</p>	<p>Division 1 certified junction box and seal fittings. The kit is designed to splice three self-regulating cables. The cable entry fitting and seal fitting combination provides a water-resistant and explosion proof seal.</p>	<p>PJ921</p>
	<p>HL-ES End Seal for Hazardous Locations</p>	<p>Division 1 certified junction box and seal fitting. The kit is designed to terminate a run of self-regulating cable. The pipe stand-off and seal fitting combination provides a water resistant and explosion proof seal.</p>	<p>PJ918</p>

Table 9 – MI Series Connection Kit Overview

	Catalog Number	Description	Installation Manual
	<p>JB-7-4 MI Cable Power Connection Kit</p>	<p>NEMA 7 cast aluminum junction box for mineral insulated cable.</p>	<p>N/A</p>
	<p>JB-7-MB MI Cable Pipe Mounting Bracket</p>	<p>Pipe mounting bracket to be used with the JB-7-4 power connection kit.</p>	<p>N/A</p>
	<p>SSW-100 Stainless Steel Tie Wire</p>	<p>Stainless steel tie wire, 100ft roll.</p>	<p>N/A</p>
	<p>SSP-1 Stainless Steel Spacer Strip</p>	<p>Stainless steel spacer strip with 1" spaced tabs, 50ft roll.</p>	<p>N/A</p>
	<p>HTC Heat Transfer Cement</p>	<p>Heat transfer cement available in 1 and 5 gallon pails.</p>	<p>N/A</p>

Accessories

Table 10 – Accessories Overview

	Catalog Number	Description	Installation Manual
	AT-1 Aluminum Tape	180 ft roll of aluminum foil installation tape. 2-mil thickness with high tensile strength; 2-1/2" wide. 200°F (93°C) rating. Minimum application temperatures 40°F (5°C).	N/A
	FT-3 Fiberglass Tape	66 ft roll of glass cloth installation tape. 3/8" wide. 500°F (260°C) rating. Strap at one-foot intervals. Minimum application temperature 40°F (5°C).	N/A
	PS Stainless Steel Pipe Straps	One (1) pipe strap used to attach kits to pipe. Available for pipe sizes 1/2" to 3/4", 1" to 3-1/2", 2-1/2" to 9", and 9" to 19.5".	N/A
	CL-1 Caution Labels	Pack of five (5) weather resistant electric heat tracing caution labels.	N/A
	SSP-1 Stainless Steel Spacer Strip	Stainless steel spacer strip with 1" spaced tabs, 50ft roll.	N/A
	SSW-100 Stainless Steel Tie Wire	Stainless steel tie wire, 100ft roll.	N/A
	HTC Heat Transfer Cement	Heat transfer cement available in 1 and 5 gallon pails.	N/A

Control Systems

Ambient Sensing

The ambient sensing control systems activate the heating cable when the ambient temperature falls below the thermostat set point. It is important that these devices are installed above ground at the pipe segment that is subject to the lowest temperatures and fastest wind speeds. The device should be placed out of direct sunlight.

Table 11 – Sensors

	Catalog Number	Description	Installation Manual
	GIC-AMB Ambient Heat Trace Sensor	Measures the ambient air temperature to prevent freeze-up of process piping that is carrying products whose temperature must be kept above freezing. The RTD sensor element is made up with a Copper sheath and can be installed directly to a controller or junction box using the 1/2" NPT conduit fitting.	N/A

Table 12 – Thermostats







	Catalog Number	Description	Installation Manual
	B-100 Freeze Protection Thermostat	The B100 direct mount thermostats feature liquid-filled thermal assemblies and sense air temperatures from 15 to 140°F. The thermostats are epoxy coated to seal from moisture and contaminants in compliance with NEMA 4X requirements.	N/A
	THL Freeze Protection Thermostat	The THL direct mount thermostats feature liquid-filled thermal assemblies and sense air temperatures from 15 to 140°F. The thermostats are epoxy coated to seal from moisture and contaminants in compliance with NEMA 4X requirements.	N/A
	TXL Freeze Protection Thermostats	The TXL direct mount thermostats feature liquid-filled thermal assemblies and sense air temperatures from 15 to 140°F. The thermostats are epoxy coated to seal from moisture and contaminants in compliance with NEMA 4X requirements.	N/A

Table 13 – Thermostats with Power Connection

	Catalog Number	Description	Installation Manual
	UAS Ambient Sensing Thermostat and Power Connection Kit	NEMA 4X rated junction box designed to connect a single cable run to power and control cable output via ambient air temperature in non-hazardous areas. This kit provides water-resistant cable entry with a 3/4" opening to accept a conduit hub (CCH-2 or equal). Temperature set point 0° to 225°F (-81°C to 107°C) with 10°F scale divisions.	PJ943
	RTAS Ambient Sensing Thermostat and Power Connection Kit	NEMA 4X rated junction box with ambient sensing thermostat. Provides temperature control and termination for one (1) cable. One (1) additional cable can be connected upon purchase of additional grommet.	PJ453
	RTAS-EP Ambient Sensing Thermostat and Power Connection Kit	Modified version of the RTAS which utilizes a hermetically sealed switch. Class I, Division 2 approved.	PJ972

Line Sensing

The line sensing control systems activate the heating cable when the pipe temperature drops below the desired setpoint. The sensor must be secured to the pipe with aluminum tape and the insulation must be sealed where the capillary comes through. The device should be mounted above ground in an area without heavy pedestrian or equipment traffic. To avoid thermal interference with the sensor, it is important that the sensor is installed at 90 degrees from the nearest heating cable or centered equally between cables if more than one heating cable is used. The sensor should ideally be installed at the end of the circuit but can be installed at any location that is at least 3 feet away from any heat sinks. See installation detail AD19.

Table 14 – Sensors



	Catalog Number	Description	Installation Manual
	RBF Heat Trace or Pipe Sensor	The RBF sensor measures the surface temperature of process piping that is carrying products whose temperatures must be controlled to prevent freeze-up, or to maintain a viscosity level so that the inner medium will flow. The Thermocouple or RTD Sensor Element is made up with a 316SS sheath and has a stainless-steel mounting pad.	N/A
	RBF-HT RTD Heat Trace Sensor	The RBF-HT sensor measures the surface temperature of process piping that is carrying products whose temperature must be controlled. The RTD sensor element is made up with a 316 SS sheath and can be installed directly to a controller or junction box using the 1/2" conduit fitting.	N/A

Table 15 – Thermostats



	Catalog Number	Description	Installation Manual
	E-100 Line Sensing Thermostat	The E100 remote mount thermostats utilize a stainless-steel bulb and capillary design to accurately sense temperature at key points along a pipe. The thermostats are epoxy coated to seal from moisture and contaminants in compliance with NEMA 4X requirements.	N/A
	THR Line Sensing Thermostat	The THR remote mount thermostats utilize a stainless-steel bulb and capillary design to accurately sense temperature at key points along a pipe. The thermostats are epoxy coated to seal from moisture and contaminants in compliance with NEMA 4X requirements.	N/A
	TXR Line Sensing Thermostat	The TXR remote mount thermostats utilize a stainless-steel bulb and capillary design to accurately sense temperature at key points along a pipe. The thermostats are epoxy coated to seal from moisture and contaminants in compliance with NEMA 4X requirements.	N/A

Table 16 – Thermostats with Power Connection



	Catalog Number	Description	Installation Manual
	<p>UBC Line Sensing Thermostat and Power Connection Kit</p>	<p>NEMA 4X rated junction box designed to connect a single cable run to power and control cable output via pipe temperature in non-hazardous areas. This kit provides water-resistant cable entry with a 3/4" opening to accept a conduit hub (CCH-2 or equal). Temperature set point 0° to 400°F (-81°C to 200°C) with 10°F scale divisions.</p>	<p>PJ942</p>
	<p>RTBC Line Sensing Thermostat and Power Connection Kit</p>	<p>NEMA 4X rated junction box with line sensing thermostat; 8" stainless steel capillary. Provides temperature control and termination for one (1) cable.</p>	<p>PJ454</p>
	<p>RTBC-EP Line Sensing Thermostat and Power Connection Kit</p>	<p>Modified version of the RTBC which utilizes a hermetically sealed switch. Class I, Division 2 approved.</p>	<p>PJ973</p>

Table 17 – Controllers







	Catalog Number	Description	Installation Manual
	<p>ITC1 & ITC2 Digital Heat Trace Controller 1 & 2 Circuits</p>	<p>Microprocessor-based system with SSR power control, full monitoring, and alarms. Single or dual point control. NEMA 4X Fiberglass and stainless steel options available.</p>	<p>PK509</p>
	<p>ITAS 2-48 ITLS 2-48 Heat Tracing Control Panel</p>	<p>Microprocessor-based control/monitoring and power management system for ambient sensing, line sensing or a combination of both. Capacity of 2-48 circuits but can be increased to 72 circuits with extension panels, ITAS-EXT 2-48 and ITLS-EXT 2-48. User-friendly touch screen HMI. NEMA 4/4X options available.</p>	<p>PK497</p>
	<p>ITASC1D2 2-48 ITLSC1D2 2-48 Heat Tracing Control Panel</p>	<p>Microprocessor-based control/monitoring and power management system for ambient sensing, line sensing or a combination of both. Capacity of 2-48 circuits but can be increased to 72 circuits with extension panels, ITASC1D2-EXT 2-48 and ITLSC1D2-EXT 2-48. User-friendly touch screen HMI. NEMA 4/4X options available.</p>	<p>PK497</p>
	<p>FPAS(M) Freeze Protection Ambient Sensing (Monitoring) Series</p>	<p>The FPAS series controls multiple heat trace circuits via an ambient sensing external thermostat, external electronic controller or via an ambient sensing, door mounted 6040 DIN controller. Chromalox recommended controllers include: RTAS, RTAS-EP, B100, E100 or the 6040 DIN controller. NEMA 4/4X options available.</p>	<p>PK557</p>
	<p>FPLS(M) Freeze Protection Line Sensing (Monitoring) Series</p>	<p>The FPLS series controls each heat trace line with individual Chromalox RTBC, RTBC-EP, E-100 or E121 line sensing controls. Each circuit should be controlled by an individual sensor/controller. Depending on the application, controllers can switch more than one circuit. NEMA 4/4X options available.</p>	<p>PK557</p>
	<p>RSP IntelliTrace Remote Sensor Panel</p>	<p>NEMA 4 Painted Steel, NEMA 4X Fiberglass or NEMA 4X 305SS enclosure. Fully integrated package that consolidates up to 252 temperature sensor signals in a single enclosure. Works seamlessly with the Chromalox IntelliTrace ITLS/ITAS heat trace control panels.</p>	<p>PK497</p>
	<p>DTS-HAZ Heat Trace Digital Thermostat</p>	<p>The DTS-HAZ digital thermostat is a NEMA 4X rated power connection kit and microprocessor-based temperature control. It is used for freeze protection or process temperature maintenance of pipes or tanks protected by heat tracing products.</p>	<p>PJ944</p>

Table 18 – Controllers Comparison

	ITC	DTS-HAZ	ITAS	ITLS	ITASC1D2	ITLSC1D2	FPAS	FPASM	FPLS	FPLSM
Controls										
Ambient sensing	•	•	•		•		•	•		
Line sensing	•	•		•		•			•	•
PASC	•		•	•	•	•				
Monitoring										
Ambient temperature	•	•	•	•	•	•	•	•		
Pipe temperature	•	•	•	•	•	•		•		•
Ground fault	•		•	•			•	•	•	•
Current	•		•	•						
Location										
Local	•	•	•	•	•	•	•	•	•	•
Remote	•		•	•	•	•		•		•
Hazardous	•	•	•*	•*	•	•	•*	•*	•*	•*
Communications										
Local display	•	•	•	•	•	•				
Remote display	•	•	•	•	•	•				
Network to DCS	•	•	•	•	•	•		•*		•*
General										
Number of circuits	1-2	1	2-72	2-72	2-72	2-72	6-42	6-42	6-42	6-42
Sensor Mapping			•	•	•	•				
BACnet	•**		•*	•*	•*	•*				
Number of circuits	110-277	110-277	120-480	120-480	120-480	120-480	120-480	120-480	120-480	120-480
Approvals	cUL/UL, CE	cUL/UL, CE, ATEX, IECEX Zone 2	cUL/UL, CE	cUL/UL, CE	cUL/UL, CE	cUL/UL, CE	cUL/UL, CE	cUL/UL, CE	cUL/UL, CE	cUL/UL, CE

*Not a standard offering.

**Not included in standard offering and only available for single circuit use.

Thermal Insulation

An installed heating circuit should be thermally insulated immediately to provide protection from damage from ongoing work. Things to remember about insulating:

- Insulate the equipment being heat traced as soon as possible after the heating cable is installed. This will protect the cable from possible physical damage.
- The type and thickness of thermal insulation specified on the design drawing must be used. If you use another type or thickness, the heater cable type or amount may have to be changed.
- Never install wet insulation. Both the piping and the insulation must be dry when thermally insulating a circuit. Wet insulation may cause start-up or operational problems.
- Properly weatherproof the thermal insulation. All places where valve stems, conduits, pipe supports, connection housing, thermal capillary tubes, etc. extend outside the insulation jacketing must be sealed with a suitable compound to keep water out.
- Insulate valves fully up to, and including, the packing gland.
- Heat trace and fully insulate the face of all non-diaphragm pressure instruments.

- Insulation must be covered by a weatherproof barrier, such as an aluminum jacket.
- If you are using metal jacketing and sheet metal screws, be sure the screws are not long enough to penetrate the thermal insulation and damage the heater cable.
- Again, perform the megger test on the circuit immediately after the thermal insulation is installed to detect if any mechanical damage may have occurred.
- When the insulation and the weatherproofing is complete, attach “Electric Traced” labels on the outside of the insulation. These should be installed where they are visible from normal operations, usually on alternating sides about every 10 feet. It is also useful to mark the location of any connections buried under the insulation.

Additional requirements for rigid thermal insulations:

- In the standard single heater cable installation, rigid insulations do not need to be oversized. However, they should be carved so there is no gap in the insulation.
- In case of redundant or multiple heater cables, rigid insulations which are 0.500 inches oversized should be used.

Commission Testing

1. Again, visually inspect the piping, insulation, and connections for the heater cable to make sure no physical damage has occurred since the installation and start-up.
2. Megger the system again to determine if damage not readily visible has occurred.
3. Turn all branch circuit breakers to the OFF position.

For systems controlled by ambient sensing thermostats:

1. If the actual ambient temperature is higher than the desired thermostat setting, turn the thermostat setting up high enough to turn the system ON or (some models) turn the selector switch to the ON position.
2. Turn the main circuit breaker ON.
3. Turn the branch breakers ON one-by-one until all are on.
4. Allow system to run at least four hours in order to let all pipes reach steady-state.
5. Measure the amperage draw, ambient temperature and pipe temperature for each circuit and record in the installation log. This information may be needed for future maintenance and troubleshooting.
6. When the system is completely checked out, reset the thermostat to the proper temperature.

For systems controlled by line sensing thermostats:

1. Set the thermostat to the desired control temperature.
2. Turn the main circuit breaker ON.
3. Turn ON the branch circuit breakers controlled by the thermostat.
4. Allow the pipe temperatures to be raised to the control point. This may take up to four hours for most circuits (large full pipes may take longer).
5. Measure the amperage draw, ambient temperature, and pipe temperature for each circuit and record in the installation log. This information may be needed for future maintenance and troubleshooting.

For redundant systems:

Follow the procedure above for the type of control system you have, but commission the systems one at a time. Start up the primary system, qualify it and shut it down. Then start up the backup system, qualify it and shut it down.

Specifications

Table 19 – CWM Cable Maximum Maintenance Temperatures

Output (W/Ft.)	Temperatures (°F)								
	3	4	6	6.7	8	9	10.1	10.6	12
w/o AT-1 Tape	340	325	293	282	262	246	229	222	200
w AT-1 Tape	350	344	332	328	320	314	307	304	296

Table 20 – SRL Circuit Breaker Selection (Max. Circuit Lengths in Ft.)

Cable Rating	50°F Start-up (Ft.)						0°F Start-up (Ft.)						-20°F Start-up (Ft.)					
	10A	15A	20A	25A	30A	40A	10A	15A	20A	25A	30A	40A	10A	15A	20A	25A	30A	40A
SRL3-1	205	305	360	NR	NR	NR	135	200	270	330	360	NR	120	185	245	300	360	NR
SRL3-2	400	600	660	NR	NR	NR	275	415	555	660	NR	NR	245	370	495	600	660	NR
SRL5-1	125	185	250	270	NR	NR	90	135	180	225	270	NR	80	120	160	205	245	270
SRL5-2	250	375	505	540	NR	NR	180	270	360	450	540	NR	160	245	325	405	490	540
SRL8-1	100	150	200	215	NR	NR	70	110	145	180	215	NR	65	100	130	165	200	210
SRL8-2	185	285	375	420	NR	NR	135	200	265	335	395	420	120	175	235	300	350	420
SRL10-1	60	95	130	160	180	NR	50	80	105	130	155	180	45	70	95	120	140	180
SRL10-2	100	160	210	260	315	360	80	125	170	210	255	340	75	120	160	195	240	320

NR = Not Required. Maximum circuit length has been reached in a smaller breaker size.

Note — Thermal magnetic circuit breakers are recommended since magnetic circuit breakers could “nuisance trip” at low temperature.

Table 21 – SRP Circuit Breaker Selection

Cable Rating	50°F Start-Up (Ft.)					0°F Start-Up (Ft.)					-20°F Start-Up (Ft.)				
	15A	20A	30A	40A	50A	15A	20A	30A	40A	50A	15A	20A	30A	40A	50A
SRP5-1	145	195	295	390	490	110	145	215	295	360	70	90	135	180	225
SRP5-2	295	385	580	750	750	220	290	430	580	720	135	180	270	360	450
SRP10-1	100	135	200	270	330	70	95	145	190	240	65	85	130	175	215
SRP10-2	200	270	400	530	665	145	190	290	380	480	130	175	260	350	440
SRP15-1	75	100	150	200	250	60	80	120	160	200	55	70	110	145	180
SRP15-2	150	195	295	390	500	120	160	235	320	400	110	145	220	290	360

Table 22 – SRM/E Circuit Breaker Selection (Max. Circuit Lengths in Ft.)

Cable Rating	50°F Start-Up (Ft.)					0°F Start-Up (Ft.)					-20°F Start-Up (Ft.)				
	15A	20A	30A	40A	50A	15A	20A	30A	40A	50A	15A	20A	30A	40A	50A
SRM/E 5-1	180	240	360	375	NR	165	220	330	375	NR	155	210	310	375	NR
SRM/E 5-2	360	480	720	750	NR	325	430	645	750	NR	310	415	620	750	NR
SRM/E 8-1	145	190	285	325	NR	135	175	265	325	NR	130	165	250	325	NR
SRM/E 8-2	285	380	575	650	NR	255	345	520	650	NR	245	335	490	650	NR
SRM/E 10-1	95	125	190	250	NR	90	110	175	250	NR	85	100	170	245	250
SRM/E 10-2	190	255	385	490	NR	165	225	345	490	NR	155	215	330	470	490
SRM/E 15-1	70	95	145	190	210	65	85	125	165	210	60	80	120	150	210
SRM/E 15-2	145	190	290	385	420	120	175	270	360	420	115	165	260	340	420
SRM/E 20-1	60	75	115	155	160	50	65	105	140	160	45	65	100	135	160
SRM/E 20-2	115	155	230	305	350	100	135	200	270	350	90	130	195	255	335

NR = Not Required. Maximum circuit length has been reached in a smaller breaker size.

Note — Thermal magnetic circuit breakers are recommended since magnetic circuit breakers could “nuisance trip” at low temperature.

Table 23 CWM Specifications

Model	Circuit Load (Amps / Ft.)	Max Circuit Length (Ft.)
CWM 4-1CT	0.033	350
CWM 8-1CT	0.067	240
CWM 12-1CT	0.100	200
CWM 4-2CT	0.017	700
CWM 8-2CT	0.033	480
CWM 12-2CT	0.050	400
CWM 12-4CT	0.025	780

Table 24 – SLL Specifications

Nominal Output Ratings on Metal Pipe - 120 VAC

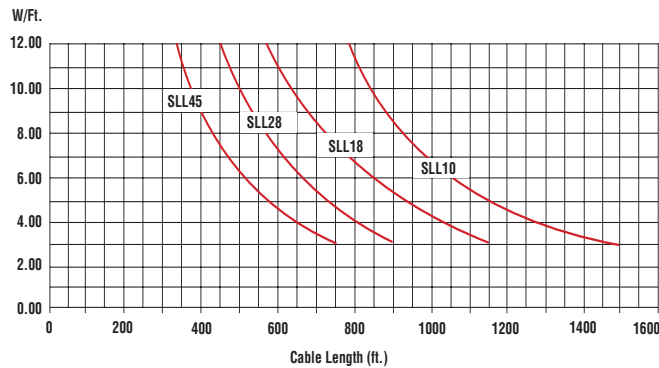

Nominal Output Ratings on Metal Pipe - 240 VAC

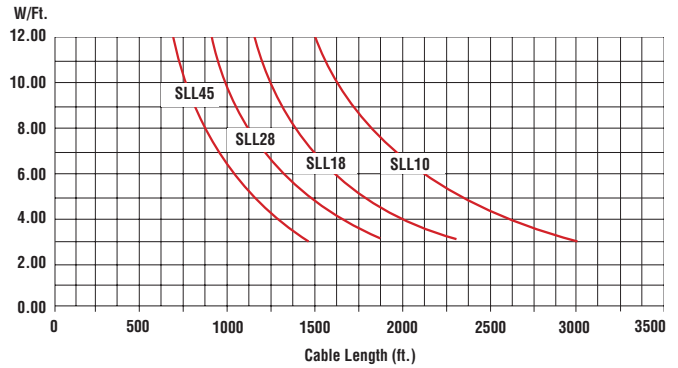

Nominal Output Ratings on Metal Pipe - 480 VAC

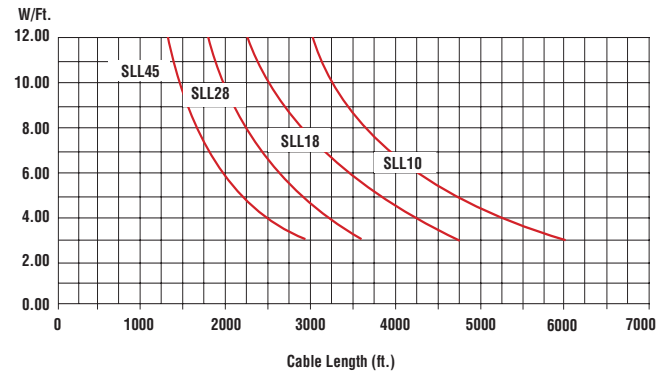

Nominal Output Ratings on Metal Pipe - 600 VAC

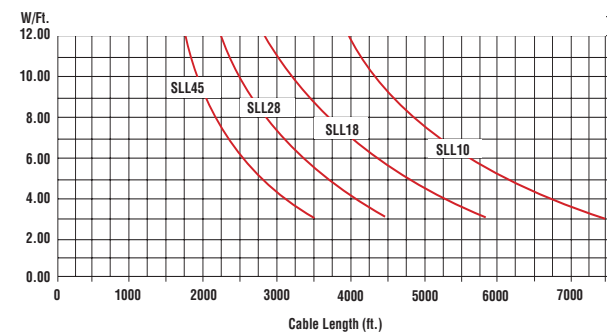

NR = Not Required. Maximum circuit length has been reached in a smaller breaker size.

Note — Thermal magnetic circuit breakers are recommended since magnetic circuit breakers could “nuisance trip” at low temperature.

Table 25 – Commercial Heating Device Installation Type

Intallation Type	Type Definition	Examples of Type		Cable Type
A	Insulated Surfaces (Including Pipe)	Hot water lines	Freeze protection	SRL, SRP, SRM/E, CWM, MI
		Sprinkler systems	Grease lines	
		Pre-insulated pipe	Fuel oil lines	
		Below grade trace heating		

Troubleshooting

Table 26 – Troubleshooting Guide

Observed Problem	Potential Causes	Corrective Actions
Pipe temperature is too low	Incorrect installation of thermostat/thermocouple	Reinstall thermostat on an appropriate pipe segment. Ensure thermocouple is fully contacting the pipe.
	Damaged, missing, or wet insulation	Remove damaged or wet insulation and install new, dry insulation. Ensure new insulation is weatherproofed.
	Improper installation of heating cable on heat sinks	Additional heating cable can be added, as long as the proper connection kits are used, and the new heating cable length does not exceed the maximum circuit length.
	Error in thermal design	Contact a Chromalox representative and modify design as needed.
	Incorrect voltage applied	Apply voltage as specified. Check/repair electrical supply lines.
Power output is too low	Damaged heating cable	Replace damaged cable. Check pipe temperature and cable power output.
	Incorrect circuit length due to uninstalled connections (splice/tee) or severed heating cable	Ensure length and heat trace path matches drawings.
	High-resistant connection due to improper installation of connection kits	Connect all splices and tees as per design specifications.
	Thermostat is wired in “Normally Open” position	Rewire to “Normally Closed” position
	The pipe temperature is too high	Lower pipe temperature if possible. Ensure correct heater selection and design. Contact a Chromalox representative and modify design if pipe temperature cannot be reduced.
	Incorrect voltage applied	Apply voltage as specified. Check/repair electrical supply lines.
Insulation resistance is low or inconsistent	Damaged heating cable	Replace damaged cable using the proper splice connection kits.
	Shorted circuit	Ensure all connection kits are installed properly and inspect them for damage. Replace if necessary.
		For uninsulated heating cable: Check the heating cable for damage, especially around heat sinks. Replace damaged cable using the proper connection kits.
		For insulated heating cable: Check the heating cable for damage piecewise at each connection kit to determine the damaged segment.
	Moisture	The Locating Faults section on page 30 can be used to estimate fault location.
		Excessive moisture on heating cable core or bus wires: Replace cable.
		Moisture on connection kits: Retest after drying out all components. Ensure all conduit entries are properly sealed during reinstallation.
Pipe temperature is too high	Retest at ambient conditions	
Test leads are in contact with junction box	Retest after moving test leads	

Observed Problem	Potential Causes	Corrective Actions
Circuit breaker trips	Undersized circuit breaker	Check design to ensure startup temperature, current loads, and maximum circuit length are not exceeded, and that the power wire size is compatible with the circuit breaker. Replace circuit breaker if necessary.
	Startup temperature is too low	Start up when temperature is higher than -76°F (-60°C).
	Damaged heating cable	Replace damaged cable using the proper connection kits.
	Bus wires touching and shorting out	Check for proper termination at end seal. Note that the heating cable could be permanently damaged and may need to be replaced.
	Moisture	Excessive moisture on heating cable core or bus wires: Replace cable.
		Moisture on connection kits: Retest after drying out all components. Ensure all conduit entries are properly sealed during reinstallation.
Undersized GFDP	Replace with appropriately sized GFDP.	

Test Procedures

⚠ WARNING

When testing any Chromalox heat trace product, always utilize the proper protective equipment and be sure to comply with all applicable safety guidelines.

⚠ WARNING

Before testing any Chromalox heat trace products, ensure that all test equipment is working as intended and has been properly calibrated.

⚠ WARNING

Only trained and qualified personnel should administer the test.

Locating Faults

The three most common test methods for finding the approximate location of a fault in a heating cable are:

- Ratio test
- Conductance test
- Capacitance test

Ratio Test

The ratio test can be used to approximate the fault location of a bus wire short or a fault from bus wire to ground braid. A standard ohmmeter is used to take resistance readings from both the front (F) and back (B) end of the cable. The fault location (L) as a percentage of cable length measured from the front end can be approximated by:

$$L (\%) = \frac{F}{F + B} * 100$$

To determine a bus wire short, the resistance reading is taken between the bus wires with one lead placed on each bus

wire. To determine a low resistance ground fault, the resistance reading is taken between the bus wires and the braid with one lead on bus wire and one on the braid.

Example: There is a bus wire short at an unknown point on a 100ft cable. The resistance reading between the bus wires is 6Ω from the front end of the cable and 14Ω from the back end.

$$L (\%) = \frac{6\Omega}{6\Omega + 14\Omega} * 100 = 30\%$$

The bus wire short is approximated to be 30ft (30% of 100ft) from the front end of the cable.

Conductance Test

The conductance test can be used to find the fault location of a severed heating cable. A standard ohmmeter is used to take resistance readings between the bus wires from both the front (F) and back (B) end of the cable. The fault location (L) as a percentage of cable length measured from the front end can be approximated by:

$$L (\%) = \frac{1/F}{1/F + 1/B} * 100$$

Example: A 100 ft long heating cable is severed at an unknown point. The bus-to-bus resistant reading is 10.0Ω from the front end and 2.5Ω from the back end.

$$L (\%) = \frac{\frac{1}{10\Omega}}{\frac{1}{10\Omega} + \frac{1}{2.5\Omega}} * 100 = 20\%$$

The cable is estimated to be severed at around 20ft (20% of 100ft) from the front of the cable.

Capacitance Test

The capacitance test can be used to estimate the length of an intact heating cable or the fault location of a severed cable that has passed the insulation resistance testing. A capacitance reading is taken between the bus wires and the braid at the end with the power connection. The bus wires should be twisted together and connected to the positive lead, and the braid should be connected to the negative lead. The fault location can be found by multiplying the recorded capacitance with the capacitance factor found in Table 25.

Example: A heating cable with a capacitance factor of 7 ft/nF is severed at an unknown point. The capacitance reading between the bus wires and the braid is 12 nF.

$$\text{Fault location} = 7 \frac{\text{ft}}{\text{nF}} * 12 \text{ nF} = 84 \text{ ft}$$

The cable is estimated to be severed at around 84ft from the power connection.

Table 27 – Capacitance Factors

Part Number	Description	Capacitance Factor (ft/nF)
SRL3-1CR/CT	3 W / FT @ 50°F - 120V	5.5
SRL3-2CR/CT	3 W / FT @ 50°F - 208-277V	5.9
SRL5-1CR/CT	5 W / FT @ 50°F - 120V	6.0
SRL5-2CR/CT	5 W / FT @ 50°F - 208-277V	5.4
SRL8-1CR/CT	8 W / FT @ 50°F - 120V	5.5
SRL8-2CR/CT	8 W / FT @ 50°F - 208-277V	5.5
SRL10-1CR/CT	10 W / FT @ 50°F - 120V	5.1
SRL10-2CR/CT	10 W / FT @ 50°F - 208-277V	5.3
SRM/E5-1CT	5 W / FT @ 50°F - 120V	7.5
SRM/E5-2CT	5 W / FT @ 50°F - 208-277V	7.2
SRM/E8-1CT	8 W / FT @ 50°F - 120V	7.5
SRM/E8-2CT	8 W / FT @ 50°F - 208-277V	7.6
SRM/E10-1CT	10 W / FT @ 50°F - 120V	7.4
SRM/E10-2CT	10 W / FT @ 50°F - 208-277V	7.4
SRM/E15-1CT	15 W / FT @ 50°F - 120V	7.9
SRM/E15-2CT	15 W / FT @ 50°F - 208-277V	7.5
SRM/E20-1CT	20W / FT @ 50°F - 120V	7.5
SRM/E20-2CT	20 W / FT @ 50°F - 208-277V	7.2

Insulation Resistance (Megger) Test

The insulation resistance test detects potential damage that could result in the cable shorting out. A megohmmeter is used to measure the insulation resistance between the conductive core and the grounding braid, and the reading is compared to the allowable minimum resistance reading (See Table 4). The megohmmeter should be a minimum of 1000 Vdc, but the use of 2500 Vdc is preferred. If possible, the meter should be battery-operated, though digital or analog meters can also be used.

1. De-energize the circuit.
2. Open the cover on the power termination kit.
3. Disconnect the bus wires and braid from the terminals.
4. Set the test voltage to 0 Vdc.
5. Connect the negative lead to the ground braid and the positive lead to the bus wires.
6. Turn on the megohmmeter and perform insulation resistance test for one minute, until the needle on the meter stops moving.
7. Check the reading and ensure it is above the allowable minimum resistance reading.
8. Record the tested value in the log.
9. Turn off the megohmmeter and discharge it with an appropriate grounding rod (if the meter does not self-discharge).
10. Reconnect the wires and close the power termination kit.

For additional information about this test, please watch the “Heat Trace Megger Testing Procedure” video in the Chromalox video library:

<https://www.chromalox.com/en/Resources-and-Support/Technical-Resources/Video-Library/Video-Library>

Stabilized Current Test

The stabilized current test determines the cable current at full voltage. It ensures that the cable power output is correct for design and that it is stable. To perform this test, a standard multimeter with an Amp clamp or an all-in-one unit is required. Ensure the meter has an auto-range up to 100A. If possible, the meter should be battery-operated, though digital or analog meters can also be used.

1. De-energize the circuit.
2. Open the cover on the power termination kit.
3. Disconnect the bus wires from the terminals.
4. Clamp the meter onto one bus wire.

5. Energize the circuit.
6. Allow the circuit to run for at least 20 minutes.
7. Take the current reading and record in the log.
8. De-energize the circuit.
9. Disconnect and turn off the meter.
10. Reconnect the bus wires and close the termination kit.

To determine the thermal output, complete the calculation below:

Thermal output = (Current Reading / Circuit Length) x Voltage

Compare the result to the charted output temperature in the “Chromalox Design Guide for Heat Tracing Products”.

For additional information about this test, please watch the “Stabilized Current Test” video in the Chromalox video library:

<https://www.chromalox.com/en/Resources-and-Support/Technical-Resources/Video-Library/Video-Library>

End of Current Voltage Test

This test determines the voltage at the end of the line, which verifies the proper voltage. To perform the test, a standard multimeter with auto-range up to 600V is required. If possible, the meter should be battery-operated, though digital or analog meters can also be used.

1. De-energize the circuit.
2. Remove the end cap.
3. Expose the bus wires.
4. Connect one test lead to each bus wire and energize the circuit.
5. Read the resulting voltage and compare it to the desired value.
6. Record the reading in the test log.
7. De-energize the circuit.
8. Disconnect and turn off the multimeter.
9. Reconnect the end cap.

For additional information about this test, please watch the “End of Current Voltage Test” video in the Chromalox video library:

<https://www.chromalox.com/en/Resources-and-Support/Technical-Resources/Video-Library/Video-Library>

Maintenance

Recommended maintenance for Chromalox heat tracing systems consists of performing the steps involved in the commission testing on a regular basis. For those systems controlled by line sensing thermostats, Chromalox recommends checking the system at least twice per year. Systems controlled by an ambient-sensing thermostat should be checked when the season requiring their use is approaching.

Repair or replace all damaged heater cable, connections, thermal insulation and weatherproofing using only Chromalox connections and methods before testing the system.

Record all repairs made and measurements taken in the installation and maintenance log.

Installation and Maintenance Log

Reference Information

Circuit Number							
Circuit Breaker Number							
Drawing Number							
Circuit Length							

Heat Tracing Visual Checks

No Signs of Moisture, Corrosion or Damage	Initial						
	Date						
Proper Electrical Connection	Initial						
	Date						
Proper Grounding of the Braid	Initial						
	Date						

Heat Tracing Electrical Checks

Megger Test (500 VDC) (Bypass Controls)	Meg Ohms						
	Date						
Amperage Draw Test Compare to design Amperage Draw	Amperage						
	Amp. Temp						
	Date						
Voltage at end of Circuit*	Voltage						
	Date						

Accessories/Control Checks

Temperature Control Properly Set	Setpoint						
	Date						
Sensors Protected and Undamaged	Initial						
	Date						
All Enclosures and Kits Closed and Sealed	Initial						
	Date						

Thermal Insulation Checks

Location of Kits Visible on Outside of Insulation	Initial						
	Date						
Insulation is Complete, Dry and Weatherproof	Initial						
	Date						

* This test must be performed at installation or at any time the cable is cut or damaged in any way.

Limited Warranty:

Please refer to the Chromalox limited warranty applicable to this product at <http://www.chromalox.com/customer-service/policies/termsofsale.aspx>.

Chromalox, Inc.
1347 Heil Quaker Boulevard
Lavergne, TN 37086
(615) 793-3900
www.chromalox.com