

CATALOG 2021

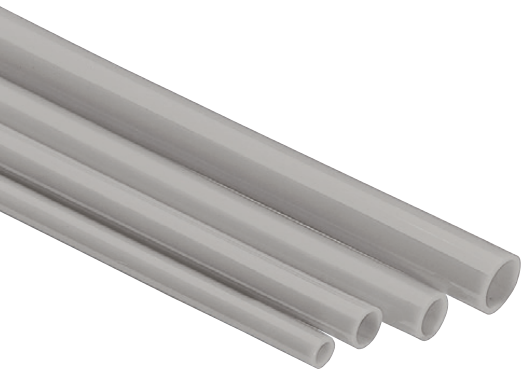

POLYAMIDE



ALUMINIUM



STAINLESS
STEEL

POINT-OF-USE



TABLE OF CONTENTS

ALUMINUM 3

PIPING

FITTINGS

CLAMPS & ACCESSORIES

TOOLS

STAINLESS STEEL 35

CLAMPS & ACCESSORIES

FITTINGS

PIPING

TOOLS

PIPE SYSTEM AND POINT-OF-USE 50

POLYAMIDE PIPES

SOCKET SYSTEM

PIPE SOCKETS

HOSES

CONNECTING & JOINING TECHNOLOGY

MAINTENANCE UNITS

ALUMINIUM

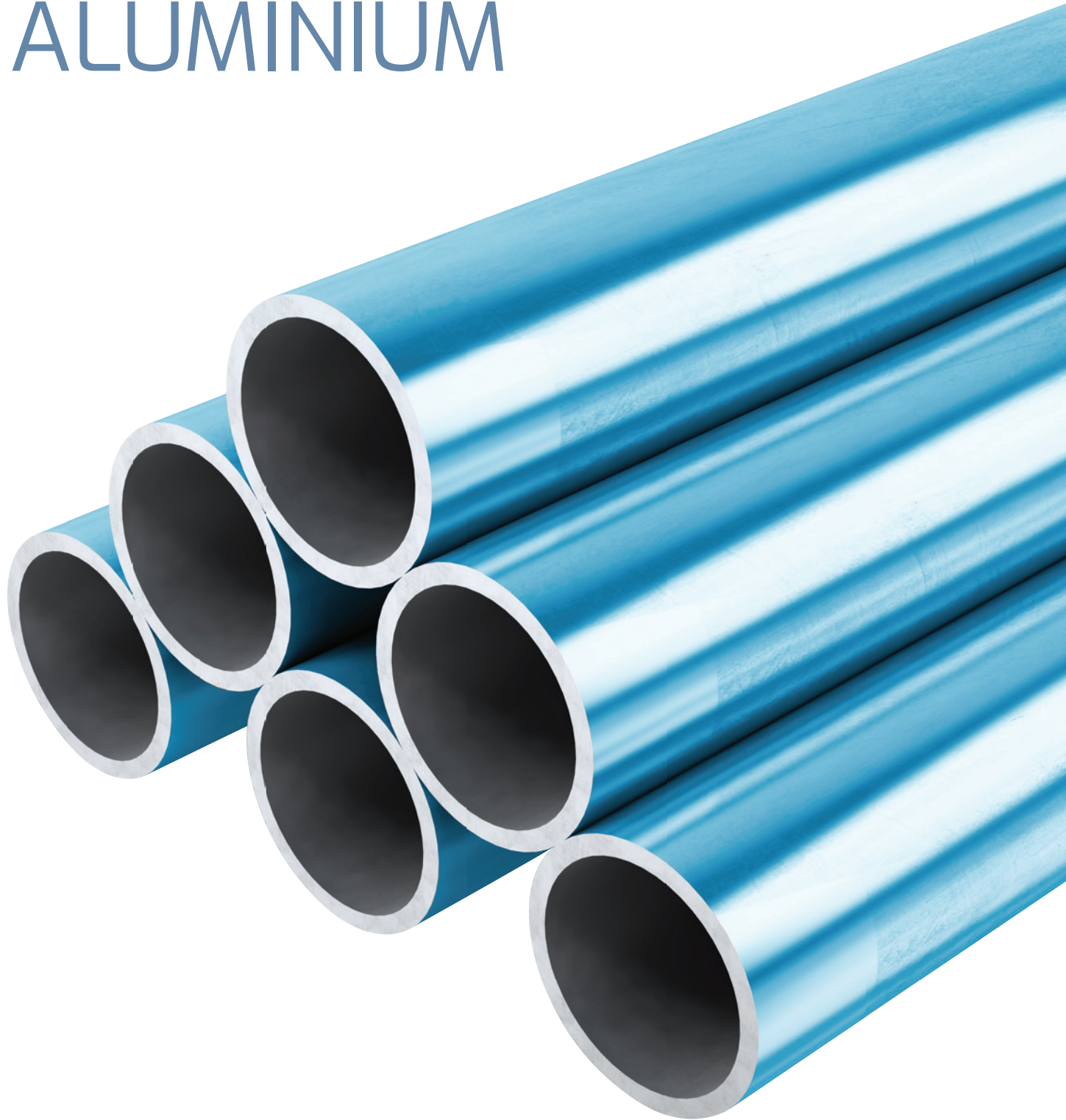

TABLE OF CONTENTS

PIPING

ALUMINIUM PIPE FOR AIR	6
ALUMINIUM PIPE FOR INERT GASES	6
ALUMINIUM PIPE TO CONNECT DROP LEGS TO QUICK DROPS	6
ALUMINIUM PIPE FOR VACUUM	7

FITTINGS

MANIFOLDS	8
EQUAL SOCKET	8
ELBOW 90°	8
ELBOW 45°	9
EQUAL TEE	9
REDUCING TEES - AIRNET	9
REDUCING TEES ISO 228	10
REDUCING TEES NPT	10
PIPE END ADAPTORS	11
REDUCTION SOCKET	11
NIPPLE SOCKET THREADED FEMALE ISO/NPT	11
NIPPLE SOCKET ISO 7-R MALE ALUMINIUM	12
NIPPLE SOCKET NPT MALE ALUMINIUM	12
ADAPTOR UNION SOCKET NPT FEMALE	13
ADAPTER UNION KIT ISO 228 FEMALE	13
ADAPTOR UNION SOCKET ISO 228 FEMALE	13
ADAPTER UNION KIT NPT FEMALE	14
WALL MOUNTED NIPPLES THREADED	14
WALL MOUNTED NIPPLES	14
QUICKDROP	15
QUICKDROP ISO 228 FEMALE	15
QUICKDROP NPT FEMALE	16
SADDLE CLAMP ISO 228 FEMALE ALUMINIUM	16
BALL VALVE	16
BALL VALVE ISO 228 FEMALE	17
BALL VALVE NPT FEMALE	17
BUTTERFLY VALVE	17
BUTTERFLY VALVES THREADED	17
FLAT GASKET	18
FLANGES	18
FLANGE SUPPORT / VALVE SUPPORT	18
FLANGE BOLTS & NUTS	18
END CAP	19

CLAMPS & ACCESSORIES

DEMOBOX	20
LABLES PRESSURE	20
LABLES VACUUM	20
PROTECTION STRAP AGAINST WHIPLASH	20
WALLBRACKET C-PROFILE	20
CANTILEVER ARM	20
CANTILVER ARM PROTECTION CAP	21
CANALIS KN HANGER	21
T-BOLTS	21
SLIDING NUT	21
PUSH-IN BEAM CLAMP FOR I PROFILE	21
SCREW BEAM CLAMP	22
U-BOLT BEAM CLAMP	22
CHANNEL C-PROFILE	22
HANG CLAMP H PROFILE	22
ROOF CLAMP	22
STRAIGHT END HOSE ISO 228 FEMALE	23
STRAIGHT END HOSE NPT FEMALE	23
ELBOW END HOSE ISO 228 FEMALE	23
ELBOW END HOSE NPT FEMALE	23
FLANGED END HOSE - STRAIGHT - DN65 DIN PN10/PN16	24
FLANGED END HOSE - ELBOW - DN65 DIN PN10/PN16	24
FLANGED END HOSE - STRAIGHT - DN80 DIN PN10/PN16	24
FLANGED END HOSE - ELBOW - DN80 DIN PN10/PN16	24
SOCKETS ISO 228 FEMALE	24
SOCKETS NPT FEMALE	24
HEXAGON NIPPLES ISO 7-R MALE	25
HEXAGON NIPPLES NPT MALE	25
NUT	25
BOLTS AND CLIPS	26
INNER PARTS	26
SEAL FOR EQUAL SOCKET VACUUM	26
O-RING FOR INNER PARTS	26
SEAL FOR EQUAL SOCKET COMPRESSED AIR	26
SEAL FOR QUICKDROP	26
CONDUCTIVITY STRAP	27
CONDUCTIVITY STRIP EQUAL SOCKET	27
CONDUCTIVITY STRIP ELBOW 90°	27
CONDUCTIVITY STRIP ELBOW 45°	27
CONDUCTIVITY STRIP EQUAL TEE	27

PIPE CLIP ADAPTOR BOLT METRIC TO METRIC	28
PIPE CLIP METRIC NUT	28
PIPE CLIP UNC NUT	28
PIPE CLIP SPACER POLYMER	29
PIPE CLIP SPACER STEEL	29
PIPE CLIP ADAPTOR BOLT UNC TO UNC	29
PIPE CLIP ADAPTOR BOLT METRIC TO UNC	29

TOOLS

LUBRICANT FOOD GRADE APPLICATION	30
TORQUE HEADS FOR BLACK SERIES	30
PIPE CUTTER ELECTRICAL	30
PIPE MARKER	30
HEXAGON ALLEN KEY	30
PIPE CUTTER MANUAL	31
TOOLBOX PF SERIES	31
PIPE DEBURRER RIGID	31
SPANNER PF SERIES	31
HOLE DEBURRER	31
SPANNER BLACK SERIES	32
SPANNER TORQUE HEAD FOR 12 MM BOLTS	32
DRILL BIT	32
DRILL BIT HOLDER	32
LUBRICANT GYMNA GEL WATERBASED	32
BELT SPANNER	32
TOOLBOX FOR Ø 63/3" - 158/6"	33

PIPING

ALUMINIUM PIPE FOR AIR

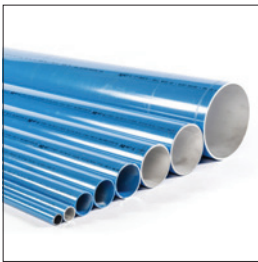

PART NUMBER	LOT SIZE	AIRNET Ø (MM / INCH)	L (M / FT)
2811 1063 10	10	20 / 3/4"	2.85 / 9.35
2811 1000 00	01	20 / 3/4"	5.70 / 18.70
2811 2063 10	10	25 / 1"	2.85 / 9.35
2811 2000 00	01	25 / 1"	5.70 / 18.70
2811 4063 00	05	40 / 1 1/2"	2.85 / 9.35
2811 4000 00	01	40 / 1 1/2"	5.70 / 18.70
2811 5063 04	04	50 / 2"	2.85 / 9.35
2811 5000 00	01	50 / 2"	5.70 / 18.70
2811 6063 03	03	63 / 2 1/2"	2.85 / 9.35
2811 6000 00	01	63 / 2 1/2"	5.70 / 18.70
2811 7063 02	02	80 / 3"	2.85 / 9.35
2811 7000 00	01	80 / 3"	5.70 / 18.70
2811 8000 00	01	100 / 4"	5.70 / 18.70
2811 9000 00	03	158 / 6"	5.70 / 18.70

ALUMINIUM PIPE FOR INERT GASES



PART NUMBER	LOT SIZE	AIRNET Ø (MM / INCH)	L (M / FT)
2811 1061 00	01	20 / 3/4"	5.70 / 18.70
2811 2061 00	01	25 / 1"	5.70 / 18.70
2811 4061 00	01	40 / 1 1/2"	5.70 / 18.70
2811 5061 00	01	50 / 2"	5.70 / 18.70
2811 6061 00	01	63 / 2 1/2"	5.70 / 18.70
2811 7061 00	01	80 / 3"	5.70 / 18.70
2811 8061 00	01	100 / 4"	5.70 / 18.70
2811 9061 00	01	158 / 6"	5.70 / 18.70

ALUMINIUM PIPE TO CONNECT DROP LEGS TO QUICK DROPS



PART NUMBER	LOT SIZE	AIRNET Ø (MM / INCH)	L (M / FT)
2811 1067 05	05	20 / 3/4"	440 / 1.44
2811 2067 05	05	25 / 1"	460 / 11/2

ALUMINIUM PIPE FOR VACUUM



PART NUMBER	LOT SIZE	AIRNET Ø (MM / INCH)	L (M / FT)
2811 1062 00	01	20 / 3/4"	5.70 / 18.70
2811 2062 00	01	25 / 1"	5.70 / 18.70
2811 5062 00	01	50 / 2"	5.70 / 18.70
2811 6062 00	01	63 / 2 1/2"	5.70 / 18.70
2811 4063 05	01	40 / 1 1/2"	5.70 / 18.70
2811 7062 00	01	80 / 3"	5.70 / 18.70
2811 8062 00	01	100 / 4"	5.70 / 18.70
2811 9062 00	01	158 / 6"	5.70 / 18.70

FITTINGS



MANIFOLDS

PART NUMBER	LOT SIZE	AIRNET Ø (MM / INCH)	DESCRIPTION
2811 10 43 80	01	20 / 4/5"	Manifold D20 NPT
2811 1042 80	01	20 / 4/5"	Manifold D20 ISO228
2811 2042 80	01	25 / 1"	Manifold D25 ISO 228
2811 2043 80	01	25 / 1"	Manifold D25 NPT



EQUAL SOCKET

PART NUMBER	LOT SIZE	AIRNET Ø (MM / INCH)
2811 1002 80	01	20 / 3/4"
2811 2002 80	01	25 / 1"
2811 4002 80	01	40 / 1 1/2"
2811 5002 80	01	50 / 2"
2811 6002 90	01	63 / 2 1/2"
2811 7002 90	01	80 / 3"
2810 8802 00	01	100 / 4"
2810 9002 00	01	158 / 6"



ELBOW 90°

PART NUMBER	LOT SIZE	AIRNET Ø (MM / INCH)
2811 1003 80	01	20 / 3/4"
2811 2003 80	01	25 / 1"
2811 4003 80	01	40 / 1 1/2"
2811 5003 80	01	50 / 2"
2811 6003 90	01	63 / 2 1/2"
2811 7003 90	01	80 / 3"
2810 8003 00	01	100 / 4"
2810 9003 00	01	158 / 6"



ELBOW 45°

PART NUMBER	LOT SIZE	AIRNET Ø (MM / INCH)
2811 1004 80	01	20 / 3/4"
2811 2004 80	01	25 / 1"
2811 4004 80	01	40 / 1 1/2"
2811 5004 80	01	50 / 2"
2811 6004 90	01	63 / 2 1/2"
2811 7004 90	01	80 / 3"
2810 8004 00	01	100 / 4"
2810 9004 00	01	158 / 6"



EQUAL TEE

PART NUMBER	LOT SIZE	AIRNET Ø (MM / INCH)
2811 1005 80	01	20 / 3/4"
2811 2005 80	01	25 / 1"
2811 4005 80	01	40 / 1 1/2"
2811 5005 80	01	50 / 2"
2811 6005 90	01	63 / 2 1/2"
2811 7005 90	01	80 / 3"
2810 8005 00	01	100 / 4"
2810 9005 00	01	158 / 6"



REDUCING TEES - AIRNET

PART NUMBER	LOT SIZE	AIRNET Ø (MM / INCH)	REDUCED THREAD OUTLET Ø (MM / INCH)
2811 2107 80	01	25 / 1"	20 / 3/4"
2811 4107 80	01	40 / 1 1/2"	20 / 3/4"
2811 4207 80	01	40 / 1 1/2"	25 / 1"
2811 5107 80	01	50 / 2"	20 / 3/4"
2811 5207 80	01	50 / 2"	25 / 1"
2811 5407 80	01	50 / 2"	40 / 1 1/2"

PART NUMBER	LOT SIZE	AIRNET Ø (MM / INCH)	REDUCED THREAD OUTLET Ø (MM / INCH)
2811 6407 90	01	63 / 2 1/2"	40 / 1 1/2"
2811 6507 90	01	63 / 2 1/2"	50 / 2"
2811 7407 90	01	80 / 3"	40 / 1 1/2"
2811 7507 90	01	80 / 3"	50 / 2"
2811 7607 90	01	80 / 3"	63 / 2 1/2"
2810 8507 00	01	100 / 4"	50 / 2"
2810 8607 00	01	100 / 4"	63 / 2 1/2"
2810 8707 00	01	100 / 4"	80 / 3"
2810 9707 00	01	158 / 6"	80 / 3"
2810 9807 00	01	158 / 6"	100 / 4"



REDUCING TEES ISO 228

PART NUMBER	LOT SIZE	AIRNET Ø (MM / INCH)	THREAD OUTLET Ø [INCH]
2811 0008 80	01	20 / 3/4"	0.38"
2811 1008 80	01	20 / 3/4"	1/2"
2811 2008 80	01	25 / 1"	1/2"
2811 2108 80	01	25 / 1"	3/4"
2811 4208 80	01	40 / 2"	1"
2811 5208 80	01	50 / 1 1/2"	1"
2811 6508 90	01	63 / 2 1/2"	2"
2811 7608 90	01	80 / 3"	2 1/2"
2811 7708 90	01	80 / 3"	3"
2810 8208 00	01	100 / 4"	1"
2810 9208 00	01	158 / 6"	1"



REDUCING TEES NPT

PART NUMBER	LOT SIZE	AIRNET Ø (MM / INCH)	REDUCED THREAD OUTLET Ø [INCH]
2811 0009 80	01	20 / 3/4"	0.38"
2811 1009 80	01	20 / 3/4"	1/2"
2811 2009 80	01	25 / 1"	1/2"
2811 2109 80	01	25 / 1"	3/4"
2811 4209 80	01	40 / 1 1/2"	1"

PART NUMBER	LOT SIZE	AIRNET Ø (MM / INCH)	REDUCED THREAD OUTLET Ø [INCH]
2811 5209 80	01	50 / 2"	1"
2811 6509 90	01	63 / 21/2"	2"
2811 7609 90	01	80 / 3"	21/2"
2811 7709 90	01	80 / 3"	3"
2810 8209 00	01	100 / 4"	1"
2810 9209 00	01	158 / 6"	1"

PIPE END ADAPTORS

PART NUMBER	LOT SIZE	AIRNET Ø (MM / INCH)	REDUCED AIRNET Ø (MM / INCH)	DESCRIPTION
2811 6462 80	01	63 / 21/2"	40 / 11/2"	Pipe end adapter D63 – D40
2811 7462 80	01	80 / 3"	40 / 11/2"	Pipe end adapter D80 – D40
2811 7562 80	01	80 / 3"	50 / 2"	Pipe end adapter D80 – D50

REDUCTION SOCKET

PART NUMBER	LOT SIZE	AIRNET Ø (MM / INCH)	REDUCED AIRNET Ø (MM / INCH)
2811 2121 80	01	25 / 1"	20 / 3/4"
2811 4221 80	01	40 / 11/2"	25 / 1"
2811 5421 80	01	50 / 21/2"	40 / 11/2"
2811 6521 90	01	63 / 21/2"	50 / 2"
2811 7621 90	01	80 / 3"	63 / 21/2"
2810 8721 00	01	100 / 4"	80 / 3"
2810 9821 00	01	158 / 6"	100 / 4"



NIPPLE SOCKET ISO 7-R MALE ALUMINIUM

PART NUMBER	LOT SIZE	AIRNET Ø (MM / INCH)	THREAD OUTLET Ø [INCH]
2811 1017 80	01	20 / 3/4"	1/2"
2811 1117 80	01	20 / 3/4"	3/4"
2811 2117 80	01	25 / 1"	3/4"
2811 2217 80	01	25 / 1"	1"
2811 4317 80	01	40 / 1 1/2"	1 1/4"
2811 4417 80	01	40 / 1 1/2"	1 1/2"
2811 5417 80	01	50 / 2"	1 1/2"
2811 5517 80	01	50 / 2"	2"
2811 6517 90	01	63 / 2 1/2"	2"
2811 6617 90	01	63 / 2 1/2"	2 1/2"
2811 7617 90	01	80 / 3"	2 1/2"
2811 7717 90	01	80 / 3"	3"



NIPPLE SOCKET NPT MALE ALUMINIUM

PART NUMBER	LOT SIZE	AIRNET Ø (MM / INCH)	THREAD OUTLET Ø [INCH]
2811 1018 80	01	20 / 3/4"	1/2"
2811 1118 80	01	20 / 3/4"	3/4"
2811 2118 80	01	25 / 1"	3/4"
2811 2218 80	01	25 / 1"	1"
2811 4318 80	01	40 / 1 1/2"	1 1/4"
2811 4418 80	01	40 / 1 1/2"	1 1/2"
2811 5418 80	01	50 / 2"	1 1/2"
2811 5518 80	01	50 / 2"	2"
2811 6518 90	01	63 / 2 1/2"	2"
2811 6618 90	01	63 / 2 1/2"	2 1/2"
2811 7618 90	01	80 / 3"	2 1/2"
2811 7718 90	01	80 / 3"	3"



ADAPTOR UNION SOCKET NPT FEMALE

PART NUMBER	LOT SIZE	AIRNET Ø (MM / INCH)	OUTLET Ø (MM / INCH)
2811 1114 80	01	20 / 3/4"	20 / 3/4"
2811 2214 80	01	25 / 1"	25 / 1"
2811 4414 80	01	40 / 1 1/2"	40 / 1 1/2"
2811 5514 80	01	50 / 2"	50 / 2"
2811 6614 90	01	63 / 2 1/2"	63 / 2 1/2"
2811 7714 90	01	80 / 3"	80 / 3"



ADAPTER UNION KIT ISO 228 FEMALE

PART NUMBER	LOT SIZE	AIRNET Ø (MM / INCH)	THREAD OUTLET Ø [INCH]
2811 0019 80	01	20 / 3/4"	0.375"
2811 1019 80	01	20 / 3/4"	1/2"
2811 2019 80	01	25 / 1"	1/2"
2811 2119 80	01	25 / 1"	3/4"
2811 4219 80	01	40 / 1 1/2"	1"
2811 5419 80	01	50 / 2"	1 1/2"
2811 5519 80	01	50 / 2"	2"
2811 6519 90	01	63 / 2 1/2"	2"
2811 7619 90	01	80 / 3"	2 1/2"
2811 7719 90	01	80 / 3"	3"



ADAPTOR UNION SOCKET ISO 228 FEMALE

PART NUMBER	LOT SIZE	AIRNET Ø (MM / INCH)	OUTLET Ø (MM / INCH)
2811 1113 80	01	20 / 3/4"	20 / 3/4"
2811 2213 80	01	25 / 1"	25 / 1"
2811 4413 80	01	40 / 1 1/2"	40 / 1 1/2"
2811 5513 80	01	50 / 2"	50 / 2"
2811 6613 90	01	63 / 2 1/2"	63 / 2 1/2"
2811 7713 90	01	80 / 3"	80 / 3"



ADAPTER UNION KIT NPT FEMALE

PART NUMBER	LOT SIZE	AIRNET Ø (MM / INCH)	THREAD OUTLET Ø [INCH]
2811 0020 80	01	20 / 3/4"	0.375"
2811 1020 80	01	20 / 3/4"	1/2"
2811 2020 80	01	25 / 1"	1/2"
2811 2120 80	01	25 / 1"	3/4"
2811 4220 80	01	40 / 1 1/2"	1"
2811 5420 80	01	50 / 2"	1 1/2"
2811 5520 80	01	50 / 2"	2"
2811 6520 90	01	63 / 2 1/2"	2"
2811 7620 90	01	80 / 3"	2 1/2"
2811 7720 90	01	80 / 3"	3"



WALL MOUNTED NIPPLES THREADED

PART NUMBER	LOT SIZE	THREAD INLET Ø [INCH]	THREAD OUTLET Ø [INCH]
2811 0025 80	01	1/2"	1/2"
2811 0026 80	01	1/2"	1/2"
2811 1025 80	01	3/4"	1/2"
2811 1026 80	01	3/4"	1/2"



WALL MOUNTED NIPPLES

PART NUMBER	LOT SIZE	AIRNET Ø (MM / INCH)	THREAD OUTLET Ø [INCH]
2811 0074 02	02	20 / 3/4"	1/2"
2811 0075 02	02	20 / 3/4"	1/2"
2811 1023 80	01	20 / 3/4"	1/2"
2811 1024 80	01	20 / 3/4"	1/2"
2811 1040 80	01	20 / 3/4"	1/2"
2811 1041 80	01	20 / 3/4"	1/2"
2811 0074 02	02	25 / 1"	1/2"
2811 0075 02	02	25 / 1"	1/2"
2811 2023 80	01	25 / 1"	1/2"

PART NUMBER	LOT SIZE	AIRNET Ø (MM / INCH)	THREAD OUTLET Ø [INCH]
2811 2024 80	01	25 / 1"	1/2"
2811 2040 80	01	25 / 1"	1/2"
2811 2041 80	01	25 / 1"	1/2"



QUICKDROP

PART NUMBER	LOT SIZE	AIRNET Ø (MM / INCH)	OUTLET Ø (MM / INCH)
2811 2110 80	01	25 / 1"	20 / 3/4"
2811 4110 80	01	40 / 1 1/2"	20 / 3/4"
2811 4210 80	01	40 / 1 1/2"	25 / 1"
2811 5110 80	01	50 / 2"	20 / 3/4"
2811 5210 80	01	50 / 2"	25 / 1"
2811 6110 80	01	63 / 2 1/2"	20 / 3/4"
2811 6210 80	01	63 / 2 1/2"	25 / 1"
2811 7110 80	01	80 / 3"	20 / 3/4"
2811 7210 80	01	80 / 3"	25 / 1"



QUICKDROP ISO 228 FEMALE

PART NUMBER	LOT SIZE	AIRNET Ø (MM / INCH)	DROP LEG THREAD OUTLET Ø [INCH]
2811 2011 80	01	25 / 1"	1/2"
2811 4011 80	01	40 / 1 1/2"	1/2"
2811 4111 80	01	40 / 1 1/2"	3/4"
2811 5011 80	01	50 / 2"	1/2"
2811 5111 80	01	50 / 2"	3/4"
2811 6011 80	01	63 / 2 1/2"	1/2"
2811 6111 80	01	63 / 2 1/2"	3/4"
2811 7011 80	01	80 / 3"	1/2"
2811 7111 80	01	80 / 3"	3/4"



QUICKDROP NPT FEMALE

PART NUMBER	LOT SIZE	AIRNET Ø (MM / INCH)	DROP LEG THREAD OUTLET Ø [INCH]
2811 2012 80	01	25 / 1"	1/2"
2811 4012 80	01	40 / 1 1/2"	1/2"
2811 4112 80	01	40 / 1 1/2"	3/4"
2811 5012 80	01	50 / 2"	1/2"
2811 5112 80	01	50 / 2"	3/4"
2811 6012 80	01	63 / 2 1/2"	1/2"
2811 6112 80	01	63 / 2 1/2"	3/4"
2811 7012 80	01	80 / 3"	1/2"
2811 7112 80	01	80 / 3"	3/4"



SADDLE CLAMP ISO 228 FEMALE ALUMINIUM

PART NUMBER	LOT SIZE	AIRNET Ø (MM / INCH)	DROP LEG THREAD OUTLET Ø [INCH]
1630 0200 00	01	100 / 4"	1"
1630 0200 03	01	158 / 6"	1"

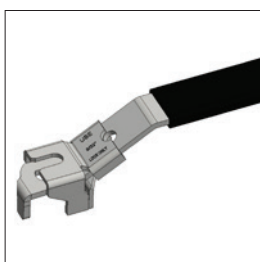

LOTO HANDLES

PART NUMBER	LOT SIZE	DESCRIPTION
2811 1251 00	01	Lockable handle D20 / 25
2811 45 51 00	01	Lockable handle D40 / 50



BALL VALVE

PART NUMBER	LOT SIZE	AIRNET Ø (MM / INCH)
2811 1051 81	01	20 / 3/4"
2811 2051 81	01	25 / 1"
2811 4051 81	01	40 / 1 1/2"
2811 5051 81	01	50 / 2"



BALL VALVE ISO 228 FEMALE

PART NUMBER	LOT SIZE	AIRNET Ø (MM / INCH)	THREAD OUTLET Ø [INCH]
2811 1152 81	01	20 / 3/4"	3/4"
2811 2252 81	01	25 / 1"	1"
2811 4452 81	01	40 / 1 1/2"	1 1/2"
2811 5552 81	01	50 / 2"	2"



BALL VALVE NPT FEMALE

PART NUMBER	LOT SIZE	AIRNET Ø (MM / INCH)	THREAD OUTLET Ø [INCH]
2811 1153 81	01	20 / 3/4"	3/4"
2811 2253 81	01	25 / 1"	1"
2811 4453 81	01	40 / 1 1/2"	1 1/2"
2811 5553 81	01	50 / 2"	2"



BUTTERFLY VALVE

PART NUMBER	LOT SIZE	AIRNET Ø (MM / INCH)
2811 6051 90	01	63 / 2 1/2"
2811 7051 90	01	80 / 3"
1606 4561 04	01	100 / 4"
2810 9051 00	01	158 / 6"



BUTTERFLY VALVES THREADED

PART NUMBER	LOT SIZE	AIRNET Ø (MM / INCH)	THREAD OUTLET Ø [INCH]
2811 6652 90	01	63 / 2 1/2"	2 1/2"
2811 6653 90	01	63 / 2 1/2"	2 1/2"
2811 7752 90	01	80 / 3"	3"
2811 7753 90	01	80 / 3"	3"



FLAT GASKET

PART NUMBER	LOT SIZE	AIRNET Ø (MM / INCH)
0650 0100 16	01	63 / 2 1/2"
0650 1001 27	01	80 / 3"
0650 0100 06	01	100 / 4"
0650 1001 25	01	158 / 6"



FLANGES

PART NUMBER	LOT SIZE	AIRNET Ø (MM / INCH)
2811 6054 90	01	63 / 2 1/2"
2811 6154 90	01	63 / 2 1/2"
2811 7054 90	01	80 / 3"
2811 7154 90	01	80 / 3"
2810 8154 00	01	100 / 4"
2810 8254 00	01	100 / 4"
2810 9154 00	01	158 / 6"



FLANGE SUPPORT / VALVE SUPPORT

PART NUMBER	LOT SIZE	AIRNET Ø (MM / INCH)
2811 1264 10	10	20 / 3/4"
2811 1264 10	10	25 / 1"
2810 0006 38	01	63 / 2 1/2"
2810 0007 38	01	80 / 3"
2810 8064 00	01	100 / 4"
2810 9064 00	01	158 / 6"



FLANGE BOLTS & NUTS

PART NUMBER	LOT SIZE	AIRNET Ø (MM / INCH)
2810 0154 08	08	100 / 4"
2810 0254 08	08	100 / 4"
2810 0354 08	08	158 / 6"
2810 0454 08	08	158 / 6"



END CAP

PART NUMBER	LOT SIZE	AIRNET Ø (MM / INCH)
2811 1006 80	01	20 / 3/4"
2811 2006 80	01	25 / 1"
2811 4006 80	01	40 / 1 3/4"
2811 5006 80	01	50 / 2"
2811 6006 90	01	63 / 2 1/2"
2811 7006 90	01	80 / 3"
2810 9816 00	01	100 / 4"
2810 9816 00	01	158 / 6"

CLAMPS & ACCESSORIES



DEMOBOX

PART NUMBER	LOT SIZE	DESCRIPTION
2810 0846 00	1	For AIRnet Ø 100
2811 0046 00	1	For AIRnet PF series

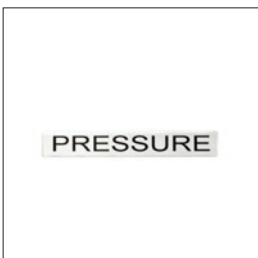

LABLES PRESSURE

PART NUMBER	LOT SIZE
2810 8067 05	05

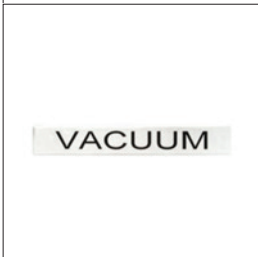

LABLES VACUUM

PART NUMBER	LOT SIZE
2810 8167 05	05



PROTECTION STRAP AGAINST WHIPLASH

PART NUMBER	LOT SIZE	AIRNET Ø (MM / INCH)
2810 0055 00	01	20-32 / 3/4"-13/4"
2810 0055 01	01	40-80 / 1 1/2"-3"



WALLBRACKET C-PROFILE

PART NUMBER	LOT SIZE	W (MM / INCH)	L (MM / INCH)
2810 0031 05	05	50 / 1.97"	76 / 3"



CANTILEVER ARM

PART NUMBER	LOT SIZE	W (MM / INCH)	L (MM / INCH)
2810 0032 05	05	40 / 1.57"	306 / 12.05"
2810 0132 00	01	40 / 1.57"	540 / 21.26"



CANTILVER ARM PROTECTION CAP

PART NUMBER	LOT SIZE
2810 0034 10	10

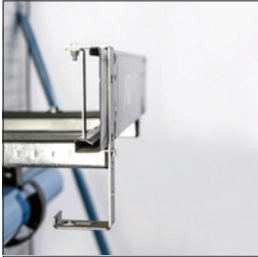

CANALIS KN HANGER

PART NUMBER	LOT SIZE
2810 0250 05	05



T-BOLTS

PART NUMBER	LOT SIZE	NUT REFERENCE	L [M]	L [INCH]
2810 0033 10	10	M8	30	1.18"
2810 0133 10	10	M8	40	1.57"
2810 0233 10	10	M8	60	2.36"
2810 0333 10	10	M8	80	3.15"



SLIDING NUT

PART NUMBER	LOT SIZE	NUT REFERENCE
2810 1033 10	10	M6



PUSH-IN BEAM CLAMP FOR I PROFILE

PART NUMBER	LOT SIZE	NUT REFERENCE	BEAM THICKNESS (MM / INCH)
2810 0035 10	10	M8	2 - 3 / 0.07 - 0.12"
2810 1035 10	10	M6	2 - 3 / 0.07 - 0.12"
2810 0135 10	10	M8	3 - 8 / 0.12 - 0.31"
2810 1135 10	10	M6	3 - 8 / 0.12 - 0.31"
2810 0235 10	10	M8	8 - 14 / 0.31 - 0.55"
2810 1235 10	10	M6	8 - 14 / 0.31 - 0.55"
2810 0335 10	10	M8	14 - 20 / 0.55 - 0.78"
2810 1335 10	10	M6	14 - 20 / 0.55 - 0.78"



SCREW BEAM CLAMP

PART NUMBER	LOT SIZE	NUT REFERENCE	BEAM THICKNESS (MM / INCH)
2810 0036 10	10	M8	1.5 - 11 / 0.06 - 0.43"
2810 1036 10	10	M6	1.5 - 11 / 0.06 - 0.43"



U-BOLT BEAM CLAMP

PART NUMBER	LOT SIZE	NUT REFERENCE
2810 0037 10	10	M6



CHANNEL C-PROFILE

PART NUMBER	LOT SIZE	W (MM / INCH)	L (MM / INCH)
2810 0030 05	05	30 / 11/5"	2000 / 78.74"



HANG CLAMP H PROFILE

PART NUMBER	LOT SIZE	NUT REFERENCE	BEAM THICKNESS (MM / INCH)
2810 0038 10	10	M8	1.5 - 4 / 0.06 - 0.16"
2811 1038 10	10	M6	1.5 - 4 / 0.59 - 0.16"
2810 0138 10	10	M8	4 - 6.5 / 0.16 - 0.25"
2811 1138 10	10	M6	4 - 6.5 / 0.16 - 0.25"



ROOF CLAMP

PART NUMBER	LOT SIZE	NUT REFERENCE	BEAM THICKNESS (MM / INCH)
2810 0039 10	10	M8	0.8 - 3 / 0.03 - 0.12"
2810 1039 10	10	M6	0.8 - 3 / 0.03 - 0.12"



STRAIGHT END HOSE ISO 228 FEMALE

PART NUMBER	LOT SIZE	THREAD OUTLET Ø [INCH]	L [MM]	L [FT]
2810 1055 00	01	3/4"	750	21/2
2810 2055 00	01	1"	750	21/2
2810 1155 00	01	3/4"	1500	4.90
2810 2155 00	01	1"	1500	4.90
2810 4155 00	01	1 1/2"	1500	4.90
2810 5155 00	01	2"	1500	4.90



STRAIGHT END HOSE NPT FEMALE

PART NUMBER	LOT SIZE	THREAD OUTLET Ø [INCH]	L [MM]	L [FT]
2810 1057 00	01	3/4"	750	21/2
2810 2057 00	01	1"	750	21/2
2810 1157 00	01	3/4"	1500	4.90
2810 2157 00	01	1"	1500	4.90
2810 4157 00	01	1 1/2"	1500	4.90
2810 5157 00	01	2"	1500	4.90



ELBOW END HOSE ISO 228 FEMALE

PART NUMBER	LOT SIZE	THREAD OUTLET Ø [INCH]	L [MM]	L [FT]
2810 4055 00	01	1 1/2"	1000	3.30
2810 5055 00	01	2"	1000	3.30



ELBOW END HOSE NPT FEMALE

PART NUMBER	LOT SIZE	THREAD OUTLET Ø [INCH]	L (MM / INCH)
2810 4057 00	01	1 1/2"	1000 / 3.30"
2810 5057 00	01	2"	1000 / 3.30"



FLANGED END HOSE - STRAIGHT - DN65 DIN PN10/PN16

PART NUMBER	LOT SIZE	L [MM]	L [FT]	BOLT PATTERN (MM / INCH)
2810 6155 00	01	1500	4.90	145 / 5.70"



FLANGED END HOSE - ELBOW - DN65 DIN PN10/PN16

PART NUMBER	LOT SIZE	L [MM]	L [FT]	BOLT PATTERN (MM / INCH)
2810 6055 00	01	1000	3.28	145 / 5.70"



FLANGED END HOSE - STRAIGHT - DN80 DIN PN10/PN16

PART NUMBER	LOT SIZE	L [MM]	L [FT]	BOLT PATTERN (MM / INCH)
2810 7155 00	01	1500	4.92	160 / 6.30"



FLANGED END HOSE - ELBOW - DN80 DIN PN10/PN16

PART NUMBER	LOT SIZE	L [MM]	L [FT]	BOLT PATTERN (MM / INCH)
2810 7055 00	01	1900	6.23	160 / 6.30"



SOCKETS ISO 228 FEMALE

PART NUMBER	LOT SIZE	THREAD Ø [INCH]
2811 0078 00	01	1/2"
2811 1178 00	01	3/4"
2811 2278 00	01	1"
2811 3378 00	01	1 1/4"
2811 4478 00	01	1 1/2"
2811 5578 00	01	2"



SOCKETS NPT FEMALE

PART NUMBER	LOT SIZE	THREAD OUTLET Ø [INCH]
2811 0079 00	01	1 1/2"

PART NUMBER	LOT SIZE	THREAD OUTLET Ø [INCH]
2811 1179 00	01	3/4"
2811 2279 00	01	1"
2811 3379 00	01	1 1/4"
2811 4479 00	01	1 1/2"
2811 5579 00	01	2"



HEXAGON NIPPLES ISO 7-R MALE

PART NUMBER	LOT SIZE	THREAD Ø [INCH]
2811 0076 00	01	1/2"
2811 1176 00	01	3/4"
2811 2276 00	01	1"
2811 4476 00	01	1 1/2"
2811 5576 00	01	2"



HEXAGON NIPPLES NPT MALE

PART NUMBER	LOT SIZE	THREAD Ø [INCH]
2811 0077 00	01	1/2"
2811 1177 00	01	3/4"
2811 2277 00	01	1"
2811 4477 00	01	1 1/2"
2811 5577 00	01	2"

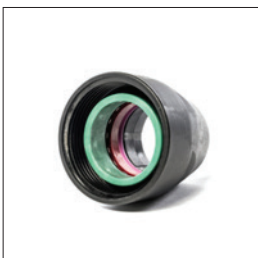

NUT

PART NUMBER	LOT SIZE	AIRNET Ø (MM / INCH)
2811 1001 12	12	20 / 3/4"
2811 2001 12	12	25 / 1"
2811 4001 12	12	40 / 1 1/2"
2811 5001 12	12	50 / 2"



BOLTS AND CLIPS

PART NUMBER	LOT SIZE	AIRNET Ø (MM / INCH)
2810 8060 10	10	100 / 4"



SEAL FOR EQUAL SOCKET VACUUM

PART NUMBER	LOT SIZE	AIRNET Ø (MM / INCH)
2810 8165 05	05	100 / 4"



O-RING FOR INNER PARTS

PART NUMBER	LOT SIZE	AIRNET Ø (MM / INCH)
2810 6065 10	10	63 / 2 1/2"
2810 7065 10	10	80 / 3"



SEAL FOR EQUAL SOCKET COMPRESSED AIR

PART NUMBER	LOT SIZE	AIRNET Ø (MM / INCH)
2810 8266 05	05	100 / 4"



SEAL FOR QUICKDROP

PART NUMBER	LOT SIZE	AIRNET Ø (MM / INCH)
2811 2065 10	10	25 / 1"
2811 4065 10	10	40-50 / 1 1/2"-2"
2811 6065 10	10	63-80 / 2 1/2"-3"



CONDUCTIVITY STRAP

PART NUMBER	LOT SIZE	AIRNET Ø (MM / INCH)
2810 0191 00	01	20-158 / 3/4"-6"



CONDUCTIVITY STRAP CONDUCTIVITY STRIP EQUAL SOCKET

PART NUMBER	LOT SIZE	AIRNET Ø (MM / INCH)
2811 1002 90	05	20-25 / 3/4"-1"
2811 4002 90	05	40 / 1 1/2"
2811 5002 90	05	50 / 2"



CONDUCTIVITY STRIP ELBOW 90°

PART NUMBER	LOT SIZE	AIRNET Ø (MM / INCH)
2811 1003 90	05	20 / 3/4"
2811 2003 90	05	25 / 1"
2811 4003 90	05	40 / 1 1/2"
2811 5003 90	05	50 / 2"



CONDUCTIVITY STRIP ELBOW 45°

PART NUMBER	LOT SIZE	AIRNET Ø (MM / INCH)
2811 1004 90	05	20 / 3/4"
2811 2004 90	05	25 / 1"
2811 4004 90	05	40 / 1 1/2"
2811 5004 90	05	50 / 2"



CONDUCTIVITY STRIP EQUAL TEE

PART NUMBER	LOT SIZE	AIRNET Ø (MM / INCH)
2811 1005 90	05	20 / 3/4"
2811 2005 90	05	25 / 1"
2811 4005 90	05	40 / 1 1/2"
2811 5005 90	05	50 / 2"



PIPE CLIP ADAPTOR BOLT METRIC TO METRIC

PART NUMBER	LOT SIZE	NUT REFERENCE
2811 0072 00	1	M6 / M8



PIPE CLIP METRIC NUT

PART NUMBER	LOT SIZE	AIRNET Ø (MM / INCH)	NUT REFERENCE
2811 1022 20	20	20 / 3/4"	M6
2811 2022 20	20	25 / 1"	M6
2811 4022 20	20	40 / 1 1/2"	M6
2811 5022 20	20	50 / 2"	M6
2811 6022 20	20	63 / 2 1/2"	M8
2811 7022 20	20	80 / 3"	M8
2810 8122 10	10	100 / 4"	M8 / M10
2810 9022 10	10	158 / 6"	M8 / M10



PIPE CLIP UNC NUT

PART NUMBER	LOT SIZE	AIRNET Ø (MM / INCH)	NUT REFERENCE
2811 1122 20	20	20 / 3/4"	1/4 UNC
2811 2122 20	20	25 / 1"	1/4 UNC
2811 4122 20	20	40 / 1 1/2"	1/4 UNC
2811 5122 20	20	50 / 2"	1/4 UNC
2811 6122 20	20	63 / 2 1/2"	5/16 UNC
2811 7122 20	20	80 / 3"	5/16 UNC
2810 9122 10	10	158 / 6"	3/8 UNC



PIPE CLIP SPACER POLYMER

PART NUMBER	LOT SIZE	SPACER HEIGHT MM (MM / INCH)
2811 0027 10	10	15 / 0.60"
2811 0127 10	10	20 / 3/4"
2811 0227 10	10	30 / 11/5"



PIPE CLIP SPACER STEEL

PART NUMBER	LOT SIZE	SPACER HEIGHT MM (MM / INCH)
2810 0227 10	10	25 / 1"
2810 0327 10	10	50 / 2"



PIPE CLIP ADAPTOR BOLT UNC TO UNC

PART NUMBER	LOT SIZE	NUT REFERENCE
2811 0172 00	1	1/4" 3/8"
2811 0272 00	1	5/16" 3/8"



PIPE CLIP ADAPTOR BOLT METRIC TO UNC

PART NUMBER	LOT SIZE	NUT REFERENCE
2811 0372 00	1	M10 3/8"

TOOLS

LUBRICANT FOOD GRADE APPLICATION



PART NUMBER	LOT SIZE
2810 0248 00	01

TORQUE HEADS FOR BLACK SERIES



PART NUMBER	AIRNET Ø (MM / INCH)
2811 6128 80	63 / 2 1/2"
2811 7128 80	80 / 3"

PIPE CUTTER ELECTRICAL



PART NUMBER	DESCRIPTION
2810 0540 80	220V/230V
2810 0640 80	110V/120V
2810 0740 00	Spare Cutter Blade

PIPE MARKER



PART NUMBER	LOT SIZE	AIRNET Ø (MM / INCH)
2811 0229 80	01	20-158 / 3/4"-6"

HEXAGON ALLEN KEY



PART NUMBER	LOT SIZE	REFERENCE (MM / INCH)
2811 0149 00	01	5 / 0.19"



PIPE CUTTER MANUAL

PART NUMBER	LOT SIZE	AIRNET Ø (MM / INCH)	DESCRIPTION
2810 0040 00	01	20-63 / 3/4"-23/4"	
2810 0340 00	01	20-63 / 3/4"-23/4"	Spare Cutter Blade
2810 0440 00	01	40-158 / 1 1/2"-6"	Spare Cutter Blade
2810 0140 00	01	50-100 / 2"-4"	
2810 0240 00	01	100-158 / 4"-6"	



TOOLBOX PF SERIES

PART NUMBER	LOT SIZE	AIRNET Ø (MM / INCH)
2811 0045 00	01	20-50 / 3/4"-2"



PIPE DEBURRER RIGID

PART NUMBER	LOT SIZE	AIRNET Ø (MM / INCH)
2810 0041 00	01	20-25 / 3/4"-1"
2810 0141 00	01	20-50 / 3/4"-2"
2810 0841 00	01	63-100 / 2 1/2"-3"



SPANNER PF SERIES

PART NUMBER	LOT SIZE	AIRNET Ø (MM / INCH)
2811 1028 00	01	20 / 3/4"
2811 2028 00	01	25 / 1"
2811 4028 00	01	40 / 1 1/2"
2811 5028 00	01	50 / 2"



HOLE DEBURRER

PART NUMBER	LOT SIZE	DESCRIPTION
2810 0042 00	01	Pen - Light Duty
2810 0641 00	01	Pen - Heavy Duty



SPANNER BLACK SERIES

PART NUMBER	LOT SIZE	AIRNET Ø (MM / INCH)
2811 6028 00	01	63 / 2 1/2"
2811 6628 00	01	63 / 2 1/2"
2811 7028 00	01	80 / 3"
2811 7728 00	01	80 / 3"



SPANNER TORQUE HEAD FOR 12 MM BOLTS

PART NUMBER	LOT SIZE	AIRNET Ø (MM / INCH)
2811 0028 80	01	100-158 / 4"-6"



DRILL BIT

PART NUMBER	LOT SIZE	AIRNET Ø (MM / INCH)	REFERENCE (MM / INCH)
2810 0143 00	01	25 / 1"	14 / 0.55"
2810 0243 00	01	40-80 / 1 1/2"-3"	24 / 0.95"



DRILL BIT HOLDER

PART NUMBER	LOT SIZE	AIRNET Ø (MM / INCH)	REFERENCE (MM / INCH)
2810 0044 00	01	25-80 / 1"-3"	14-24 / 0.55"-0.95"



LUBRICANT GYMNA GEL WATERBASED

PART NUMBER	LOT SIZE	DESCRIPTION
2810 0148 00	01	Water base lubricator



BELT SPANNER

PART NUMBER	LOT SIZE	AIRNET Ø (MM / INCH)
2810 8028 00	01	40-80 / 1 1/2"-3"



TOOLBOX FOR Ø 63/3" - 158/6"

PART NUMBER	LOT SIZE	AIRNET Ø (MM / INCH)
2811 0245 00	01	63-158 / 21/2"-6"



In line with the high quality performance of the AIRnet product range, we provide our customers with a 10 year guarantee.

TO ACHIEVE THE LOWEST TOTAL COST OF OWNERSHIP AIRnet OFFERS

- ✓ HIGH QUALITY MATERIALS
- ✓ OPTIMAL OPERATIONAL PERFORMANCE
- ✓ LOW OPERATIONAL COSTS
- ✓ LOW INSTALLATION COSTS
- ✓ LOW MODIFICATION COSTS
- ✓ SAFETY

STAINLESS STEEL



TABLE OF CONTENTS

CLAMPS & ACCESSORIES

PIPE CLIP	37
PIPE CLIP UNC	37
O-RING KIT	37
GASKET	38

FITTINGS

QUICK DROP	39
SWAN NECK	39
ELBOW 45°	39
ELBOW 90°	40
EQUAL TEE	40
REDUCING TEE	40
THREADED REDUCING TEE ISO228	41
THREADED REDUCING TEE NPT	41
EQUAL SOCKET	42
NIPPLE SOCKET MALE ISO 7-R	42
NIPPLE SOCKET MALE NPT	43
NIPPLE SOCKET FEMALE ISO228	44
NIPPLE SOCKET FEMALE NPT	44
END CAP	44

WALL MOUNTED NIPPLE	45
REDUCER MALE X FEMALE	45
ADAPTER UNION FEMALE ISO228	45
ADAPTER UNION FEMALE NPT	46
FLANGE DIN PN16	46
FLANGE ANSI CL150	46
BALL VALVE	47
COMPENSATOR	47

PIPING

PIPE 304L	48
PIPE 316L	48

TOOLS

PRESSING TOOL	49
TOOL JAW	49
PIPE MARKER	49
PIPE DEBURRER	49

CLAMPS & ACCESSORIES



PIPE CLIP

PART NUMBER	DESCRIPTION	AIRNET Ø (MM / INCH)	LOT SIZE
2812 1022 20	Pipe Clip 304L D15 (1/2") M6 20PCS	15 / 1/2"	20
2812 2022 20	Pipe Clip 304L D28 (1") M8 20PCS	28 / 1"	20
2812 3022 20	Pipe Clip 304L D35 (1 1/4") M8 20PCS	35 / 1 1/4"	20
2812 4022 20	Pipe Clip 304L D42 (1 1/2") M8 20PCS	42 / 1 1/2"	20
2812 5022 20	Pipe Clip 304L D54 (2") M8 20PCS	54 / 2"	20
2812 6022 20	Pipe Clip 304L D76 (2 3/4") M10 20PCS	76 / 2 3/4"	20
2812 7022 20	Pipe Clip 304L D89 (3 1/2") M10 20PCS	89 / 3 1/2"	20
2812 8022 20	Pipe Clip 304L D108 (4") M10 20PCS	108 / 4"	20



PIPE CLIP UNC

PART NUMBER	DESCRIPTION	AIRNET Ø (MM / INCH)	LOT SIZE
2812 1122 20	Pipe Clip 304L D15 (1/2") 3/8" UNC 20PCS	15 / 1/2"	20
2812 2122 20	Pipe Clip 304L D28 (1") 3/8" UNC 20PCS	28 / 1"	20
2812 3122 20	Pipe Clip 304L D35 (1 1/4") 3/8" UNC 20PCS	35 / 1 1/4"	20
2812 4122 20	Pipe Clip 304L D42 (1 1/2") 3/8" UNC 20PCS	42 / 1 1/2"	20
2812 5122 20	Pipe Clip 304L D54 (2") 3/8" UNC 20PCS	54 / 2"	20
2812 6122 20	Pipe Clip 304L D76 (2 3/4") 3/8" UNC 20PCS	76 / 2 3/4"	20
2812 7122 20	Pipe Clip 304L D89 (3 1/2") 3/8" UNC 20PCS	89 / 3 1/2"	20
2812 8122 20	Pipe Clip 304L D108 (4") 3/8" UNC 20PCS	108 / 4"	20



O-RING KIT

PART NUMBER	DESCRIPTION	AIRNET Ø (MM / INCH)	LOT SIZE
2812 1065 20	O-ring Kit D15 (1/2") 20PCS	15 / 1/2"	20
2812 2065 20	O-ring Kit D28 (1") 20PCS	28 / 1"	20

PART NUMBER	DESCRIPTION	AIRNET Ø (MM / INCH)	LOT SIZE
2812 3065 20	O-ring Kit D35 (1 1/4") 20PCS	35 / 1 1/4"	20
2812 4065 20	O-ring Kit D42 (1 1/2") 20PCS	42 / 1 1/2"	20
2812 5065 20	O-ring Kit D54 (2") 20PCS	54 / 2"	20
2812 6065 10	O-ring Kit D76 (2 3/4") 10PCS	76 / 2 3/4"	10
2812 7065 10	O-ring Kit D89 (3 1/2") 10PCS	89 / 3 1/2"	10
2812 8065 10	O-ring Kit D108 (4") 10PCS	108 / 4"	10



GASKET

PART NUMBER	DESCRIPTION	AIRNET Ø (MM / INCH)	LOT SIZE
0650 0100 43	Gasket for Flange D15 (1/2") PN10-16 / ANSI CL150	15 / 1/2"	1
0650 0100 99	Gasket for Flange D28 (1") PN10-16	28 / 1"	1
0650 0101 06	Gasket for Flange D28 (1") ANSI CL150	28 / 1"	1
0650 1001 12	Gasket for Flange D35 PN10-16 / ANSI CL150	35 / 1 1/4"	1
0650 1000 87	Gasket for Flange D42 (1 1/2") PN10-16	42 / 1 1/2"	1
0650 0100 09	Gasket for Flange D54 (2") PN10-16 / ANSI CL150	54 / 2"	1
0650 1001 07	Gasket for Flange D76 (2 3/4") PN10-16	76 / 2 3/4"	1
0650 1001 19	Gasket for Flange D76 (2 3/4") ANSI CL150	76 / 2 3/4"	1
0650 1001 27	Gasket for Flange D89 (3 1/2") PN10-16 / ANSI CL150	89 / 3 1/2"	1
0650 0100 06	Gasket for Flange D108 (4") PN10-16 / ANSI CL150	108 / 4"	1

FITTINGS



QUICK DROP

PART NUMBER	DESCRIPTION	DIMENSIONS (MM / INCH)	LOT SIZE
2812 6310 00	Quick Drop 316L D76xD35 (2 3/4"x1 1/4")	76x35 / 23/4"	1
2812 7410 00	Quick Drop 316L D89xD42 (3 1/2"x1 1/2")	89x42 / 31/2"	1
2812 8510 00	Quick Drop 316L D108xD54 (4"x2")	108x54 / 4"	1



SWAN NECK

PART NUMBER	DESCRIPTION	AIRNET Ø (MM / INCH)	LOT SIZE
2812 1067 00	Swan Neck 316L D15 (1/2")	15 / 1/2"	1
2812 2067 00	Swan Neck 316L D28 (1")	28 / 1"	1



ELBOW 45°

PART NUMBER	DESCRIPTION	AIRNET Ø (MM / INCH)	LOT SIZE
2812 1004 00	Elbow 45 DEG 316L D15 (1/2")	15 / 1/2"	1
2812 2004 00	Elbow 45 DEG 316L D28 (1")	28 / 1"	1
2812 3004 00	Elbow 45 DEG 316L D35 (1 1/4")	35 / 11/4"	1
2812 4004 00	Elbow 45 DEG 316L D42 (1 1/2")	42 / 11/2"	1
2812 5004 00	Elbow 45 DEG 316L D54 (2")	54 / 2"	1
2812 6004 00	Elbow 45 DEG 316L D76 (2 3/4")	76 / 23/4"	1
2812 7004 00	Elbow 45 DEG 316L D89 (3 1/2")	89 / 31/2"	1
2812 8004 00	Elbow 45 DEG 316L D108 (4")	108 / 4"	1



ELBOW 90°

PART NUMBER	DESCRIPTION	AIRNET Ø (MM / INCH)	LOT SIZE
2812 1003 00	Elbow 90 DEG 316L D15 (1/2")	15 / 1/2"	1
2812 2003 00	Elbow 90 DEG 316L D28 (1")	28 / 1"	1
2812 3003 00	Elbow 90 DEG 316L D35 (1 1/4")	35 / 1 1/4"	1
2812 4003 00	Elbow 90 DEG 316L D42 (1 1/2")	42 / 1 1/2"	1
2812 5003 00	Elbow 90 DEG 316L D54 (2")	54 / 2"	1
2812 6003 00	Elbow 90 DEG 316L D76 (2 3/4")	76 / 2 3/4"	1
2812 7003 00	Elbow 90 DEG 316L D89 (3 1/2")	89 / 3 1/2"	1
2812 8003 00	Elbow 90 DEG 316L D108 (4")	108 / 4"	1



EQUAL TEE

PART NUMBER	DESCRIPTION	AIRNET Ø (MM / INCH)	LOT SIZE
2812 1005 00	Equal Tee 316L D15 (1/2")	15 / 1/2"	1
2812 2005 00	Equal Tee 316L D28 (1")	28 / 1"	1
2812 3005 00	Equal Tee 316L D35 (1 1/4")	35 / 1 1/4"	1
2812 4005 00	Equal Tee 316L D42 (1 1/2")	42 / 1 1/2"	1
2812 5005 00	Equal Tee 316L D54 (2")	54 / 2"	1
2812 6005 00	Equal Tee 316L D76 (2 3/4")	76 / 2 3/4"	1
2812 7005 00	Equal Tee 316L D89 (3 1/2")	89 / 3 1/2"	1
2812 8005 00	Equal Tee 316L D108 (4")	108 / 4"	1



REDUCING TEE

PART NUMBER	DESCRIPTION	AIRNET Ø (MM / INCH)	LOT SIZE
2812 2107 00	Reducing Tee 316L D28xD15 (1"x1/2")	28 / 1"	1
2812 3207 00	Reducing Tee 316L D35xD28 (1 1/4"x1")	35 / 1 1/4"	1
2812 4307 00	Reducing Tee 316L D42xD35 (1 1/2"x1 1/4")	42 / 1 1/2"	1
2812 5407 00	Reducing Tee 316L D54xD42 (2"x1 1/2")	54 / 2"	1

PART NUMBER	DESCRIPTION	AIRNET Ø (MM / INCH)	LOT SIZE
2812 6507 00	Reducing Tee 316L D76xD54 (2 3/4"x2")	76 / 23/4"	1
2812 7607 00	Reducing Tee 316L D89xD76 (3 1/2"x2 3/4")	89 / 31/2"	1
2812 8707 00	Reducing Tee 316L D108xD89 (4"x3 1/2")	108 / 4"	1

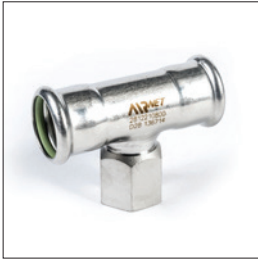

THREADED REDUCING TEE ISO228

PART NUMBER	DESCRIPTION	AIRNET Ø (MM / INCH)	LOT SIZE
2812 1008 00	Threaded Reducing Tee 316L D15x1/2" (1/2"x1/2") ISO228	15 / 1/2"	1
2812 2108 00	Threaded Reducing Tee 316L D28x3/4" (1"x3/4") ISO228	28 / 1"	1
2812 3108 00	Threaded Reducing Tee 316L D35x3/4" (1 1/4"x3/4") ISO228	35 / 11/4"	1
2812 4108 00	Threaded Reducing Tee 316L D42x3/4" (1 1/2"x3/4") ISO228	42 / 11/2"	1
2812 5108 00	Threaded Reducing Tee 316L D54x3/4" (2"x3/4") ISO228	54 / 2"	1
2812 6108 00	Threaded Reducing Tee 316L D76x3/4" (2 3/4"x3/4") ISO228	76 / 23/4"	1
2812 7108 00	Threaded Reducing Tee 316L D89x3/4" (3 1/2"x3/4") ISO228	89 / 31/2"	1
2812 8108 00	Threaded Reducing Tee 316L D108x3/4" (4"x3/4") ISO228	108 / 4"	1



THREADED REDUCING TEE NPT

PART NUMBER	DESCRIPTION	AIRNET Ø (MM / INCH)	LOT SIZE
2812 1009 00	Threaded Reducing Tee 316L D15x1/2" (1/2"x1/2") NPT	15 / 1/2"	1
2812 2109 00	Threaded Reducing Tee 316L D28x3/4" (1"x3/4") NPT	28 / 1"	1
2812 3109 00	Threaded Reducing Tee 316L D35x3/4" (1 1/4"x3/4") NPT	35 / 11/4"	1
2812 4109 00	Threaded Reducing Tee 316L D42x3/4" (1 1/2"x3/4") NPT	42 / 11/2"	1
2812 5109 00	Threaded Reducing Tee 316L D54x3/4" (2"x3/4") NPT	54 / 2"	1
2812 6109 00	Threaded Reducing Tee 316L D76x3/4" (2 3/4"x3/4") NPT	76 / 23/4"	1
2812 7109 00	Threaded Reducing Tee 316L D89x3/4" (3 1/2"x3/4") NPT	89 / 31/2"	1
2812 8109 00	Threaded Reducing Tee 316L D108x3/4" (4"x3/4") NPT	108 / 4"	1



EQUAL SOCKET

PART NUMBER	DESCRIPTION	AIRNET Ø (MM / INCH)	LOT SIZE
2812 1002 00	Equal Socket 316L D15 (1/2")	15 / 1/2"	1
2812 2002 00	Equal Socket 316L D28 (1")	28 / 1"	1
2812 3002 00	Equal Socket 316L D35 (1 1/4")	35 / 1 1/4"	1
2812 4002 00	Equal Socket 316L D42 (1 1/2")	42 / 1 1/2"	1
2812 5002 00	Equal Socket 316L D54 (2")	54 / 2"	1
2812 6002 00	Equal Socket 316L D76 (2 3/4")	76 / 2 3/4"	1
2812 7002 00	Equal Socket 316L D89 (3 1/2")	89 / 3 1/2"	1
2812 8002 00	Equal Socket 316L D108 (4")	108 / 4"	1



NIPPLE SOCKET MALE ISO 7-R

PART NUMBER	DESCRIPTION	AIRNET Ø (MM / INCH)	LOT SIZE
2812 1017 00	Nipple Socket Male 316L D15x1/2" (1/2"x1/2") ISO7R	15 / 1/2"	1
2812 1117 00	Nipple Socket Male 316L D15x3/4" (1/2"x3/4") ISO7R	15 / 1/2"	1
2812 2117 00	Nipple Socket Male 316L D28x3/4" (1"x3/4") ISO7R	28 / 1"	1
2812 2217 00	Nipple Socket Male 316L D28x1" (1"x1") ISO7R	28 / 1"	1
2812 3217 00	Nipple Socket Male 316L D35x1" (1 1/4"x1") ISO7R	35 / 1 1/4"	1
2812 3317 00	Nipple Socket Male 316L D35x1 1/4" (1 1/4"x1 1/4") ISO7R	35 / 1 1/4"	1
2812 4317 00	Nipple Socket Male 316L D42x1 1/4" (1 1/2"x1 1/4") ISO7R	42 / 1 1/2"	1
2812 4417 00	Nipple Socket Male 316L D42x1 1/2" (1 1/2"x1 1/2") ISO7R	42 / 1 1/2"	1
2812 5417 00	Nipple Socket Male 316L D54x1 1/2" (2"x1 1/2") ISO7R	54 / 2"	1
2812 5517 00	Nipple Socket Male 316L D54x2" (2"x2") ISO7R	54 / 2"	1
2812 6617 00	Nipple Socket Male 316L D76x2 1/2" (2 3/4"x2 1/2") ISO7R	76 / 2 3/4"	1
2812 7717 00	Nipple Socket Male 316L D89x3" (3 1/2"x3") ISO7R	89 / 3 1/2"	1
2812 8817 00	Nipple Socket Male 316L D108x4" (4"x4") ISO7R	108 / 4"	1



NIPPLE SOCKET MALE NPT

PART NUMBER	DESCRIPTION	AIRNET Ø (MM / INCH)	LOT SIZE
2812 1018 00	Nipple Socket Male 316L D15x1/2" (1/2"x1/2") NPT	15 / 1/2"	1
2812 1118 00	Nipple Socket Male 316L D15x3/4" (1/2"x3/4") NPT	15 / 1/2"	1
2812 2118 00	Nipple Socket Male 316L D28x3/4" (1"x3/4") NPT	28 / 1"	1
2812 2218 00	Nipple Socket Male 316L D28x1" (1"x1") NPT	28 / 1"	1
2812 3218 00	Nipple Socket Male 316L D35x1" (1 1/4"x1") NPT	35 / 11/4"	1
2812 3318 00	Nipple Socket Male 316L D35x1 1/4" (1 1/4"x1 1/4") NPT	35 / 11/4"	1
2812 4318 00	Nipple Socket Male 316L D42x1 1/4" (1 1/2"x1 1/4") NPT	42 / 11/2"	1
2812 4418 00	Nipple Socket Male 316L D42x1 1/2" (1 1/2"x1 1/2") NPT	42 / 11/2"	1
2812 5418 00	Nipple Socket Male 316L D54x1 1/2" (2"x1 1/2") NPT	54 / 2"	1
2812 5518 00	Nipple Socket Male 316L D54x2" (2"x2") NPT	54 / 2"	1
2812 6618 00	Nipple Socket Male 316L D76x2 1/2" (2 3/4"x2 1/2") NPT	76 / 23/4"	1
2812 7718 00	Nipple Socket Male 316L D89x3" (3 1/2"x3") NPT	89 / 31/2"	1
2812 8818 00	Nipple Socket Male 316L D108x4" (4"x4") NPT	108 / 4"	1

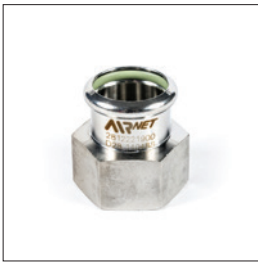
NIPPLE SOCKET FEMALE ISO228

PART NUMBER	DESCRIPTION	AIRNET Ø (MM / INCH)	LOT SIZE
2812 1119 00	Nipple Socket Female 316L D15x3/4" (1/2"x3/4") ISO228	15 / 1/2"	1
2812 2219 00	Nipple Socket Female 316L D28x1" (1"x1") ISO228	28 / 1"	1
2812 3319 00	Nipple Socket Female 316L D35x1 1/4" (1 1/4"x1 1/4") ISO228	35 / 11/4"	1
2812 4419 00	Nipple Socket Female 316L D42x1 1/2" (1 1/2"x1 1/2") ISO228	42 / 11/2"	1
2812 5519 00	Nipple Socket Female 316L D54x2" (2"x2") ISO228	54 / 2"	1

NIPPLE SOCKET FEMALE NPT

PART NUMBER	DESCRIPTION	AIRNET Ø (MM / INCH)	LOT SIZE
2812 1120 00	Nipple Socket Female 316L D15x3/4" (1/2"x3/4") NPT	15 / 1/2"	1
2812 2220 00	Nipple Socket Female 316L D28x1" (1"x1") NPT	28 / 1"	1
2812 3320 00	Nipple Socket Female 316L D35x1 1/4" (1 1/4"x1 1/4") NPT	35 / 11/4"	1
2812 4420 00	Nipple Socket Female 316L D42x1 1/2" (1 1/2"x1 1/2") NPT	42 / 11/2"	1
2812 5520 00	Nipple Socket Female 316L D54x2" (2"x2") NPT	54 / 2"	1

END CAP

PART NUMBER	DESCRIPTION	AIRNET Ø (MM / INCH)	LOT SIZE
2812 1006 00	End Cap 316L D15 (1/2")	15 / 1/2"	1
2812 2006 00	End Cap 316L D28 (1")	28 / 1"	1
2812 3006 00	End Cap 316L D35 (1 1/4")	35 / 11/4"	1
2812 4006 00	End Cap 316L D42 (1 1/2")	42 / 11/2"	1
2812 5006 00	End Cap 316L D54 (2")	54 / 2"	1
2812 6006 00	End Cap 316L D76 (2 3/4")	76 / 23/4"	1
2812 7006 00	End Cap 316L D89 (3 1/2")	89 / 31/2"	1
2812 8006 00	End Cap 316L D108 (4")	108 / 4"	1



WALL MOUNTED NIPPLE

PART NUMBER	DESCRIPTION	AIRNET Ø (MM / INCH)	LOT SIZE
2812 1040 00	Wall Mounted Nipple 316L D15x1/2" (1/2"x1/2") ISO228	15 / 1/2"	1
2812 1041 00	Wall Mounted Nipple 316L D15x1/2" (1/2"x1/2") NPT	15 / 1/2"	1



REDUCER MALE X FEMALE

PART NUMBER	DESCRIPTION	DIMENSIONS (MM / INCH)	LOT SIZE
2812 2121 00	Reducer Male x Female 316L D28xD15 (1"x1/2")	28x15 / 1/2"	1
2812 3221 00	Reducer Male x Female 316L D35xD28 (1 1/4"x1")	35x28 / 11/4"	1
2812 4321 00	Reducer Male x Female 316L D42xD35 (1 1/2"x1 1/4")	42x35 / 11/2"	1
2812 5421 00	Reducer Male x Female 316L D54xD42 (2"x1 1/2")	54x42 / 21/2"	1
2812 6521 00	Reducer Male x Female 316L D76xD54 (2 3/4"x2")	76x54 / 23/4"	1
2812 7621 00	Reducer Male x Female 316L D89xD76 (3 1/2"x2 3/4")	89x76 / 31/2"	1
2812 8721 00	Reducer Male x Female 316L D108xD89 (4"x3 1/2")	108x89 / 41/2"	1



ADAPTER UNION FEMALE ISO228

PART NUMBER	DESCRIPTION	AIRNET Ø (MM / INCH)	LOT SIZE
2812 1113 00	Adapter Union Female 316L D15x3/4" (1/2"x3/4") ISO228	15 / 1/2"	1
2812 2213 00	Adapter Union Female 316L D28x1" (1"x1") ISO228	28 / 1"	1
2812 3313 00	Adapter Union Female 316L D35x1 1/4" (1 1/4"x1 1/4") ISO228	35 / 11/4"	1
2812 4413 00	Adapter Union Female 316L D42x1 1/2" (1 1/2"x1 1/2") ISO228	42 / 11/2"	1
2812 5513 00	Adapter Union Female 316L D54x2" (2"x2") ISO228	54 / 2"	1

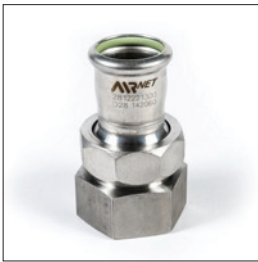

ADAPTER UNION FEMALE NPT

PART NUMBER	DESCRIPTION	AIRNET Ø (MM / INCH)	LOT SIZE
2812 1114 00	Adapter Union Female 316L D15x3/4" (1/2"x3/4") NPT	15 / 1/2"	1
2812 2214 00	Adapter Union Female 316L D28x1" (1"x1") NPT	28 / 1"	1
2812 3314 00	Adapter Union Female 316L D35x1 1/4" (1 1/4"x1 1/4") NPT	35 / 1 1/4"	1
2812 4414 00	Adapter Union Female 316L D42x1 1/2" (1 1/2"x1 1/2") NPT	42 / 1 1/2"	1
2812 5514 00	Adapter Union Female 316L D54x2" (2"x2") NPT	54 / 2"	1



FLANGE DIN PN16

PART NUMBER	DESCRIPTION	AIRNET Ø (MM / INCH)	LOT SIZE
2812 1054 00	Flange 316L D15 (1/2") DIN PN16	15 / 1/2"	1
2812 2054 00	Flange 316L D28 (1") DIN PN16	28 / 1"	1
2812 3054 00	Flange 316L D35 (1 1/4") DIN PN16	35 / 1 1/4"	1
2812 4054 00	Flange 316L D42 (1 1/2") DIN PN16	42 / 1 1/2"	1
2812 5054 00	Flange 316L D54 (2") DIN PN16	54 / 2"	1
2812 6054 00	Flange 316L D76 (2 3/4") DIN PN16	76 / 2 3/4"	1
2812 7054 00	Flange 316L D89 (3 1/2") DIN PN16	89 / 3 1/2"	1
2812 8054 00	Flange 316L D108 (4") DIN PN16	108 / 4"	1



FLANGE ANSI CL150

PART NUMBER	DESCRIPTION	AIRNET Ø (MM / INCH)	LOT SIZE
2812 1154 00	Flange 316L D15 (1/2") ANSI CL150	15 / 1/2"	1
2812 2154 00	Flange 316L D28 (1") ANSI CL150	28 / 1"	1
2812 3154 00	Flange 316L D35 (1 1/4") ANSI CL150	35 / 1 1/4"	1
2812 4154 00	Flange 316L D42 (1 1/2") ANSI CL150	42 / 1 1/2"	1
2812 5154 00	Flange 316L D54 (2") ANSI CL150	54 / 2"	1

PART NUMBER	DESCRIPTION	AIRNET Ø (MM / INCH)	LOT SIZE
2812 6154 00	Flange 316L D76 (2 3/4") ANSI CL150	76 / 23/4"	1
2812 7154 00	Flange 316L D89 (3 1/2") ANSI CL150	89 / 31/2"	1
2812 8154 00	Flange 316L D108 (4") ANSI CL150	108 / 4"	1



BALL VALVE

PART NUMBER	DESCRIPTION	AIRNET Ø (MM / INCH)	LOT SIZE
2812 1051 00	Ball Valve 316L D15 (1/2")	15 / 1/2"	1
2812 2051 00	Ball Valve 316L D28 (1")	28 / 1"	1
2812 3051 00	Ball Valve 316L D35 (1 1/4")	35 / 11/4"	1
2812 4051 00	Ball Valve 316L D42 (1 1/2")	42 / 11/2"	1
2812 5051 00	Ball Valve 316L D54 (2")	54 / 2"	1
2812 6051 00	Ball Valve 316L D76 (2 3/4")	76 / 23/4"	1
2812 7051 00	Ball Valve 316L D89 (3 1/2")	89 / 31/2"	1
2812 8051 00	Ball Valve 316L D108 (4")	108 / 4"	1



COMPENSATOR

PART NUMBER	DESCRIPTION	AIRNET Ø (MM / INCH)	LOT SIZE
2812 1055 00	Compensator 316L D15 (1/2")	15 / 1/2"	1
2812 2055 00	Compensator 316L D28 (1")	28 / 1"	1
2812 3055 00	Compensator 316L D35 (1 1/4")	35 / 11/4"	1
2812 4055 00	Compensator 316L D42 (1 1/2")	42 / 11/2"	1
2812 5055 00	Compensator 316L D54 (2")	54 / 2"	1

PIPING



PIPE 304L

PART NUMBER	DESCRIPTION	LOT SIZE	AIRNET Ø (MM / INCH)	L (M / FT)
2812 1000 00	Pipe 304L D15 (1/2")	1	15 / 1/2"	5.70 / 18.70
2812 2000 00	Pipe 304L D28 (1")	1	28 / 1"	5.70 / 18.70
2812 3000 00	Pipe 304L D35 (1 1/4")	1	35 / 1 1/4"	5.70 / 18.70
2812 4000 00	Pipe 304L D42 (1 1/2")	1	42 / 1 1/2"	5.70 / 18.70
2812 5000 00	Pipe 304L D54 (2")	1	54 / 2"	5.70 / 18.70
2812 6000 00	Pipe 304L D76 (2 3/4")	7	76 / 2 3/4"	5.70 / 18.70
2812 7000 00	Pipe 304L D89 (3 1/2")	4	89 / 3 1/2"	5.70 / 18.70
2812 8000 00	Pipe 304L D108 (4")	4	108 / 4"	5.70 / 18.70



PIPE 316L

PART NUMBER	DESCRIPTION	LOT SIZE	AIRNET Ø (MM / INCH)	L (M / FT)
2812 1001 00	Pipe 316L D15 (1/2")	1	15 / 1/2"	5.70 / 18.70
2812 2001 00	Pipe 316L D28 (1")	1	28 / 1"	5.70 / 18.70
2812 4001 00	Pipe 316L D42 (1 1/2")	1	42 / 1 1/4"	5.70 / 18.70

TOOLS



PRESSING TOOL

PART NUMBER	DESCRIPTION	AIRNET Ø (MM / INCH)	LOT SIZE
2812 0028 00	Pressing Tool D15-D54 (1/2" - 2")	15-54 / 1/2"-2"	1
2812 4528 00	Tool Adapter D42-D54 (1 1/2" - 2")	42-54 / 1 1/2"-2"	1
2812 0128 00	Pressing Tool D76-D108 (2 3/4" - 4")	76-108 / 2 3/4"-4"	1
2812 0228 00	Battery	/	1
2812 0328 00	Charger	/	1
2812 0428 00	Power Cable	/	1



TOOL JAW

PART NUMBER	DESCRIPTION	AIRNET Ø (MM / INCH)	LOT SIZE
2812 1028 00	Tool Jaw D15 (1/2")	15 / 1/2"	1
2812 2028 00	Tool Jaw D28 (1")	28 / 1"	1
2812 3028 00	Tool Jaw D35 (1 1/4")	35 / 1 1/4"	1
2812 4028 00	Tool Collar D42 (1 1/2")	42 / 1 1/2"	1
2812 5028 00	Tool Collar D54 (2")	54 / 2"	1
2812 6028 00	Tool Collar D76 (2 3/4")	76 / 2 3/4"	1
2812 7028 00	Tool Collar D89 (3 1/2")	89 / 3 1/2"	1
2812 8028 00	Tool Collar D108 (4")	108 / 4"	1



PIPE MARKER

PART NUMBER	DESCRIPTION
2812 0029 80	Insertion depth marker



PIPE DEBURRER

PART NUMBER	DESCRIPTION	AIRNET Ø (MM / INCH)	LOT SIZE
2810 0041 00	-	20-25 / 3/4"-1"	1
2810 0141 00	-	20-50 / 3/4"-2"	1
2810 0841 00	-	63-100 / 2 1/2"-3"	1

Pipe system and point of use

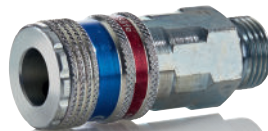

AIRnet 15-28mm range

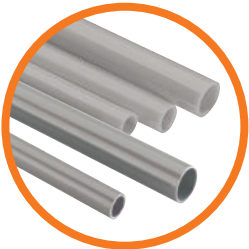

Polyamide pipe diameter
15-28mm in rolls or in pipe
length
Aluminum pipe 15-28mm

Page 9



Stainless steel click-fit
connectors, with integrated
retaining claws acting as a
force lock for pipe
retaining

Page 10



Compressed air outlet
compatible with AIRnet
system, and compatible
with outlet couplers

Page 15-16



Hoses and workshop
connection and extension
to connect to your point of
use, fits different
requirements

Page 18-23



For all connections on
tools, hoses and machines,
from the simple nipple to
the more complex safety
quick-action coupling.

Page 24-30



Filters and maintenance
units – from prefilters and
microfilters through to
activated carbon filters

Page 31-32

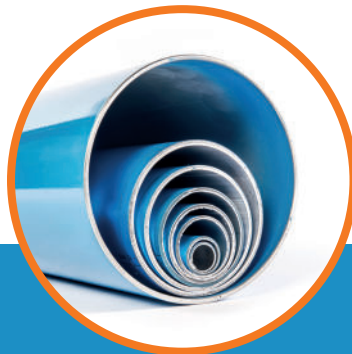

Aluminum pipe from
20(3/4') to 158mm (6')



Range fitting from Push
– to-fit, torque-to-grip,
or bolt clamp assembly
system

Consult the AIRNet entire
range, including larger instal-
lation solutions for heavy
duty industrial systems for
compressed air and vacuum.

Preventing your money from vanishing into thin air: pipe systems of AIRnet!



Maximum efficiency in pipe network

An efficient compressed air system must include a well designed pipe network because a correctly designed pipe system minimises the pressure lost from the line.

We would be glad to help you design your pipe system: We will design the perfect pipe system and appropriate connection points for you based on your individual requirements analysis for maximum efficiency – always with consideration for the long-term future development of your company.



Optimisation of existing pipe systems

Leaks in the pipe system can generate high costs: In smaller industry and trade networks the average leak is 5%, in larger networks it may even be 10-15%* (based on consumption during production times).

Additional costs resulting from leaks*

ø leak [mm]	Air loss at 6 bar [l/sec.]	Energy loss/year at 8.760 h/a and 0,19 €/kWh [kWh] [€]	
1	1.24	2,891	549.29
3	11.14	26,017	4.943.23
5	30.95	72,270	13,731.30

* Source: Bavarian Environmental Protection Agency (Hrsg.): „Protect the climate – Reduce costs: Guideline for efficient energy use in trade and industry“, 1st edition, Augsburg, 2004

Calculate your pipeline diameter!

To plan a compressed air pipeline correctly, greatest importance should be attached to the dimensions and the materials selected because selecting small cross-sections and compressed air pipelines susceptible to corrosion can result in high pressure losses.

The perfect pipe system in four steps:

1. Select the right pipe system according to your compressed air requirements

See the previous page for the four different materials available.

2. Choose a ring or stub line depending on your space requirements:

A stub line is suitable for individual compressed air outlets and for bridging small distances. If you intend to install several compressed air outlets on different sides of the room, a ring line is recommended because the same pressure is guaranteed at all connection points in the network.

Refer to the tables on the following page for:

- the dimensions of a **stub line**: the total nominal length of the line and the total compressed air requirements
- the dimensions of a **ring line**: half the nominal length of the line and the total compressed air requirements

3. Select the fittings required for your pipeline:

For flowing compressed air every fitting is a resistance, a substitute pipeline length must be included for each fitting accordingly. These lengths can be taken from the table on the following page. When choosing the fittings, consider the pipeline diameter already calculated in point 2.

Example:	Substitute pipe length	Nominal length
2 angles \varnothing 28 mm	1.5 m	3.0 m
5 T-pieces \varnothing 28 mm	2.0 m	10.0 m
Total		13.4 m

4. Calculate your pipeline diameter:

Add the nominal length of the pipeline from point 2 and the substitute length for fittings from point 3 to get the total length. With this length you can take the correct pipeline diameter for your personal requirements from the tables on the following pages.

Design data for pipelines

Substitute pipeline lengths for fittings

Working overpressure 7 bar, Δp (max.) 0.2 bar, flow speed (max.) 10 m/s

Fittings	Comparable with	3/8"	1/2"	3/4"	1"	1 1/4"	1 1/4"	1 1/2"	1 1/2"	2"	2 1/2"
Dia.	inner	12	14	18	24	28	32	38	38	50	63
Dia.	outer	15	18	22	28	32	40	40	50	63	80
Ball valve		0.1	0.2	0.3	0.4	0.5	0.5	0.6	0.6	0.7	0.8
Angle 45°		0.4	0.5	0.7	0.7	1.0	1.0	1.3	1.3	1.8	2.0
Angle 90°		0.7	1.0	1.3	1.5	2.0	2.0	2.5	2.5	3.5	4.0
T-piece		0.8	1.0	1.5	2.0	2.5	2.5	3.0	3.0	4.0	5.0
Reduction fitting 2d to d		0.4	0.5	0.5	0.6	0.7	0.7	0.8	0.8	1.0	1.5

Compressed air distribution with closed ring line

For dimensioning the ring line, take half of the nominal length of the total ring line and the entire compressed air requirements into consideration:

Length A B C = 250 m, length D E F = 250 m
Half closed ring line length: 250 m

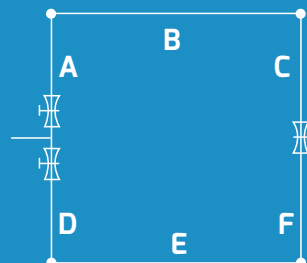

Design data for pipelines

Polyamide (PA) pipe/plug-in system 15-28 mm

Working overpressure 7 bar, Δp (max.) 0.2 bar, flow speed (max.) 10 m/s

Compressed air flow rate	Length of the pipeline [m]														
	N[l/s]	N[l/min]	N[m ³ /min]	25	50	75	100	150	200	250	300	400	500	750	1.000
1,7	100	0,1	15	15	15	15	15	15	15	15	15	18	18	18	22
3,3	200	0,2	15	15	15	15	18	18	22	22	22	22	22	22	28
5,0	300	0,3	15	15	18	18	22	22	22	22	28	28	28	28	28
6,7	400	0,4	15	18	22	22	22	22	28	28	28	28	28	28	>28
8,3	500	0,5	18	22	22	22	22	28	28	28	28	28	28	>28	>28
12,5	750	0,8	22	22	22	28	28	28	28	>28	>28	>28	>28	>28	>28
16,7	1.000	1,0	22	28	28	28	28	>28	>28	>28	>28	>28	>28	>28	>28
25,0	1.500	1,5	28	28	28	>28	>28	>28	>28	>28	>28	>28	>28	>28	>28
33,3	2.000	2,0	28	>28	>28	>28	>28	>28	>28	>28	>28	>28	>28	>28	>28

Diameter > 28 mm – see AIRnet PF/Black series

Aluminium pipe/plug-in system 15-28 mm

Working overpressure 7 bar, Δp (max.) 0.2 bar, flow speed (max.) 10 m/s

Compressed air flow rate	Length of the pipeline [m]														
	N[l/s]	N[l/min]	N[m ³ /min]	25	50	75	100	150	200	250	300	400	500	750	1.000
1,7	100	0,1	15	15	15	15	15	15	15	15	15	18	18	18	18
3,3	200	0,2	15	15	15	15	18	18	18	18	22	22	22	22	28
5,0	300	0,3	15	15	18	18	18	18	22	22	22	28	28	28	28
6,7	400	0,4	15	18	18	22	22	22	22	28	28	28	28	28	>28
8,3	500	0,5	18	18	22	22	22	22	28	28	28	28	28	>28	>28
12,5	750	0,8	18	22	22	28	28	28	28	28	28	>28	>28	>28	>28
16,7	1.000	1,0	22	28	28	28	28	>28	>28	>28	>28	>28	>28	>28	>28
25,0	1.500	1,5	28	28	28	>28	>28	>28	>28	>28	>28	>28	>28	>28	>28
33,3	2.000	2,0	28	28	>28	>28	>28	>28	>28	>28	>28	>28	>28	>28	>28
50,0	3.000	3,0	28	>28	>28	>28	>28	>28	>28	>28	>28	>28	>28	>28	>28

Diameter > 28 mm – see AIRnet PF/Black series

Aluminium pipe/AIRnet 20-158 mm

Working overpressure 7 bar, Δp (max.) 0.2 bar, flow speed (max.) 10 m/s

Compressed air flow rate	Length of the pipeline [m]												
	N[l/s]	N[l/min]	N[m ³ /min]	50	100	150	300	500	750	1.000	1.300	1.600	2.000
3	200	0,2	20	20	20	20	20	20	20	20	20	20	25
8	500	0,5	20	20	20	25	25	25	40	40	40	40	40
14	800	0,8	20	20	25	25	40	40	40	40	40	40	40
19	1.200	1,2	20	25	25	40	40	40	40	40	40	40	40
28	1.700	1,7	25	25	40	40	40	40	40	40	50	50	50
42	2.500	2,5	25	40	40	40	40	40	50	50	50	50	63
69	4.000	4	40	40	40	50	50	50	63	63	63	63	63
97	6.000	6	40	40	50	50	50	63	63	63	80	80	80
139	8.000	8	40	50	50	63	63	63	80	80	80	80	100
208	13.000	13	50	63	63	63	80	80	80	100	100	100	100
278	17.000	17	50	63	63	80	80	100	100	100	100	100	158
347	21.000	21	63	63	80	80	100	100	100	100	158	158	158
417	25.000	25	63	80	80	100	100	100	100	158	158	158	158
486	29.000	29	63	80	80	100	100	158	158	158	158	158	158
556	33.000	33	63	80	80	100	158	158	158	158	158	158	158
694	42.000	42	80	80	100	158	158	158	158	158	158	158	158
833	50.000	50	80	100	100	158	158	158	158	158	158	158	158
972	58.000	58	80	100	100	158	158	158	158	158	158	200	200
1.111	67.000	67	100	100	158	158	158	158	158	158	200	200	200
1.250	75.000	75	100	158	158	158	158	158	158	200	200	200	200
1.389	83.000	83	100	158	158	158	158	158	158	200	200	200	200
1.528	92.000	92	100	158	158	158	158	158	200	200	200	200	200
1.667	100.000	100	100	158	158	158	158	158	200	200	200	200	200

Diameter > 158 mm not in supply range

Socket system 15-28 mm

Laid, extended and modified in an instant



Huge time savings with simple, quick assembly of pipes and connectors

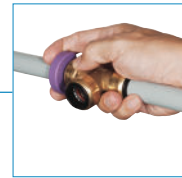

Flexible system for simple release and reconnection



Large number of stainless steel retaining claws hold the pipe securely in the plug connectors

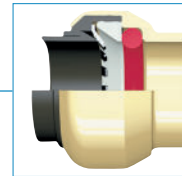

Resistant O-ring ensures complete impermeability, even if the air contains oil



Example: Equal tee D22

For small and medium-sized workshops: Lay pipelines quickly and easily with a few hand movements with the AIRnet pipe system and extend or modify existing pipelines – the flexible plug-in system offers a wide selection of different connectors.

Click it – the innovative pipe system

Hardly any other pipe system is changed as often as a compressed air network: No problem with the „Click it“ system: The connection can be detached easily with only a few hand movements and without causing damage to the pipe or connector. All parts can then be reused.



1. Cut the pipe to the right size

Accurate to the millimetre using the Schneider airsystems pipe shears.



2. Deburr and chamfer

So that everything runs smoothly and fits together, visually and otherwise.



3. Join the pipes using plug connectors

When inserted as far as the stop, the pipe is completely airtight and the simple installation saves an enormous amount of time.



4. Disassembly with just a few hand movements

Press clip against connector – pull pipe out of connector – and you're done.

The Click-it plug connectors

- 1 | The stainless steel retaining claw provides a force lock for retaining the pipe securely
- 2 | Oil-resistant O-ring for complete impermeability, even with oil containing compressed air
- 3 | Spacer washer for centring the pipe in the fitting exactly

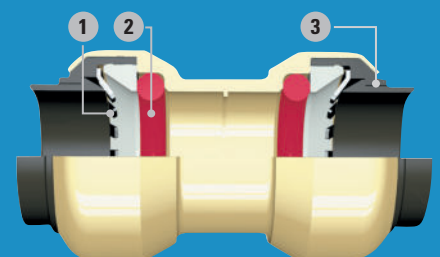

Polyamide pipes

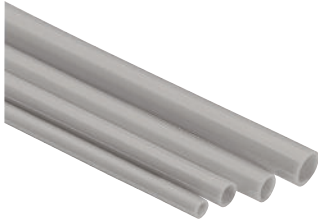

- Polyamide (PA) for greater flexibility
- Pipe shears cut pipelines to length in a single cut

- ▶ Free of silicone
- ▶ Black UV-resistant pipes, suitable for outdoor installation

	Designation	Model	Art. no.	System/dia.				Length (m)	Packaging unit (pc.)	
				15	18	22	28			
	Rolled pipe, grey ¹⁾	PA Pipe D15 25m	2813110000	■				25	1	
		PA Pipe D18 25m	2813210000		■			25	1	
		PA Pipe D22 25m	2813310000			■		25	1	
		PA Pipe D28 25m	2813410000				■	25	1	
		PA Pipe D15 10m	2813120000		■				10	1
		PA Pipe D18 10m	2813220000			■			10	1
	Lengths of pipe, grey ²⁾	PA Pipe D15 5,7m	2813100000	■				6	1	
		PA Pipe D18 5,7m	2813200000		■			6	1	
		PA Pipe D22 5,7m	2813300000			■		6	1	
		PA Pipe D28 5,7m	2813400000				■	6	1	
	Rolled pipe, black ¹⁾	PA UV Pipe D15 25m	2813130000	■				25	1	
		PA UV Pipe D18 25m	2813230000		■			25	1	
		PA UV Pipe D22 25m	2813330000			■		25	1	
	Lengths of pipe, black ²⁾	PA UV Pipe D22 5,7m	2813320000			■		6	1	

1) Max. operating pressure for rolled pipe: 14 bar at -20 °C to ≤ +20 °C; 11 bar at +20 °C to ≤ +50 °C

2) Max. operating pressure for lengths of pipe: 16 bar at -20 °C to ≤ +20 °C; 11 bar at +20 °C to ≤ +50 °C

Socket system 15-28 mm

Click-it brass plug connector

- Simple, quick assembly for huge time savings
- Flexible system for simple release and reconnection
- Resistant O-ring made from NBR ensures complete impermeability, even if the air contains oil
- Large number of stainless steel retaining claws hold the pipe securely in the plug connectors

▶	Material: Brass
▶	Free of silicone
▶	Max. operating pressure: 16 bar at -20 °C to ≤ +50 °C



Model	Art. no.	System/dia.				Packaging unit (pc.)	Designation	
		15	18	22	28			
Nipple socket D15 1/2 ISO7R m	2813101780	■				1	Straight male push-in connexion	
Nipple socket D18 3/4 ISO7R m	2813211780		■			1		
Nipple socket D18 1/2 ISO7R m	2813201780		■			1		
Nipple socket D22 3/4 ISO7R m	2813311780			■		1		
Nipple socket D22 1/2 ISO7R m	2813301780			■		1		
Nipple socket D28 1 ISO7R m	2813421780				■	1	Straight female push-in connexion	
Nipple socket D15 1/2 ISO228 f	2813101980	■				1		
Nipple socket D18 1/2 ISO228 f	2813201980		■			1		
Nipple socket D18 3/4 ISO228 f	2813211980		■			1		
Nipple socket D22 1/2 ISO228 f	2813301980			■		1		
Nipple socket D22 3/4 ISO228 f	2813311980			■		1	Straight push-in connexion	
Nipple socket D28 1 ISO228 f	2813421980				■	1		
Equal socket D15	2813100280	■				1		
Equal socket D18	2813200280		■			1		
Equal socket D22	2813300280			■		1		
Equal socket D28	2813400280				■	1	Right-angle plug connector 90°	
90 Deg Elbow D15	2813100380	■				1		
90 Deg Elbow D18	2813200380		■			1		
90 Deg Elbow D22	2813300380			■		1		
90 Deg Elbow D28	2813400380				■	1		
45 Deg Elbow D15	2813100480	■				1	Angle plug connector 45°	
45 Deg Elbow D18	2813200480		■			1		
45 Deg Elbow D22	2813300480			■		1		
45 Deg Elbow D28	2813400480				■	1		
90 Deg Elbow D15-1/2 ISO7R m	2813100381	■				1		
90 Deg Elbow D18-1/2 ISO7R m	2813200381		■			1		
90 Deg Elbow D22-3/4 ISO7R m	2813310381			■		1		
90 Deg Elbow D28-1 ISO7R m	2813420381				■	1		
Equal tee D15	2813100580	■				1	T-branch push-in connexion	
Equal tee D18	2813200580		■			1		
Equal tee D22	2813300580			■		1		
Equal tee D28	2813400580				■	1		
Reduction tee D22 D15 D22	2813310780	■				1		
Reduction tee D22 D18 D22	2813320780		■			1	Reducing push-in connexion	
Reduction tee D28 D22 D22	2813430781			■		1		
Reduction tee D28 D18 D28	2813420780		■			1		
Reduction tee D28 D22 D28	2813430780			■		1		
Pipe end adapter D22-D15	2813316280	■				1		
Pipe end adapter D22-D18	2813326280		■			1	Sliding sleeve	
Pipe end adapter D28-D18	2813426280		■			1		
Pipe end adapter D28-D22	2813436280			■		1		
Sliding equal socket D15	2813100281	■				1		
Sliding equal socket D18	2813200281		■			1		
Sliding equal socket D22	2813300281			■		1	Blind cap	
Sliding equal socket D28	2813400281				■	1		
End cap D15	2813100680	■				1		
End cap D18	2813200680		■			1		
End cap D22	2813300680			■		1		
End cap D28	2813400680				■	1	Connecting adapter <i>Please note: it is mandatory to insert a notch into the connecting piece with the all-purpose tool 2813024000!</i>	
Threaded ad. D15-1/2 ISO7R m	2813101300	■				1		
Threaded ad. D18-1/2 ISO7R m	2813201300		■			1		
Threaded ad. D18-3/4 ISO7R m	2813211300		■			1		
Threaded ad. D22-1/2 ISO7R m	2813301300			■		1		
Threaded ad. D22-3/4 ISO7R m	2813311300			■		1	Threaded ad. D28-1 ISO7R m	
Threaded ad. D28-1 ISO7R m	2813421300				■	1		

Air shut-off cock



- Simple shut-off function ensures a high degree of energy efficiency and safety of the supply network
- For shutting off individual areas of a stub, ring or outlet line
- Plug connector not preassembled

▶ NBR seal



Model	Art. no.	System/dia.			
		15	18	22	28
Ball valve D15 ¹⁾	2813105180	■			
Ball valve D18 ¹⁾	2813205180		■		
Ball valve D22 ¹⁾	2813305180			■	
Ball valve D28 ¹⁾	2813405180				■

1) Max. operating pressure: 16 bar at -20 °C to ≤ +50 °C

Assembly aids

	Designation	Model	Art. no.	System/dia.				Support thickness (mm)	Packaging unit (pc.)
				15	18	22	28		
	Pipe clips	Pipe clip D15	2813102200	■				25	
		Pipe clip D18	2813202200		■			25	
		Pipe clip D22	2813302200			■		25	
		Pipe clip D28	2813402200				■	25	
	Pipe clamps	Pipe clamp D15-D18	2813122200	■	■			25	
		Pipe clamp D22	2813332200			■		25	
		Pipe clamp D28	2813442200				■	25	
	Hanger bolt for pipe clamps							25	
	Disassembly pliers	Disassembly pliers D15	2813102800	■				1	
		Disassembly pliers D18	2813202800		■			1	
		Disassembly pliers D22	2813302800			■		1	
		Disassembly pliers D28	2813402800				■	1	
	Disassembly clip	Disassembly clip D15	2813112800	■				1	
		Disassembly clip D18	2813222800		■			1	
		Disassembly clip D22	2813332800			■		1	
		Disassembly clip D28	2813442800				■	1	

Socket system 15-28 mm

Marking and deburring tool

- For chamfering and deburring aluminium pipes, marking insertion depths and notching indentations on hard surfaces (e.g. V4A pipelines)

Model	Art. no.
Marking and deburring tool	2813024000



Shear

- For cutting PA pipes, max. dia. 28 mm (with reversible blade)
- With impact function

Model	Art. no.
Shear	2813004000
2 spare blades shear	2813014000



Pipe cutter

- For aluminium and stainless steel pipes, dia. 15-32 mm

Model	Art. no.
Pipe Cutter D32	2813034000
Pipe Cutter D32 cutting wheel	2813044000



Deburring tool

- For deburring plastic, aluminium and stainless steel pipes
- For inner and outer diameters up to 35 mm

Model	Art. no.
Deburring tool D35	2813054000



Deburring blade

- For deburring the inner diameter of aluminium pipes

Model	Art. no.
Deburring blade	2813064000



Anti-friction agent

- For easy installation of compressed air pipes
- Free of silicone

Model	Art. no.
Anti-friction agent	2813074000



Pipe sockets 15-22 mm

Innovative and flexible –
for greater economic efficiency



Extremely durable body made of impact-resistant, glass-fibre reinforced polyamide



Very flexible, can be used as an input block, through block, distribution block or dead-end distribution block

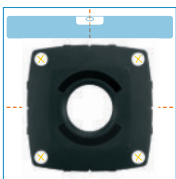

Uncomplicated assembly because the screens of the Basic sockets also serve as drilling templates and spirit level supports



Great flexibility with top sockets available in three different versions



Protection of lines as the air outlet is directed downwards to avoid bending hoses

Example: Socket Box 2x1/2 and Socket Box Top 4x1/2

Install perfect compressed air outlets in the pipe system for each workplace – versatile pipe sockets are fully compatible with the Schneider airtsystems pipe system and various attachment parts, and can be extended by fitting additional outlet components.

A flexible system with unimagined possibilities

Long-lasting and permanently tight
thanks to metal thread inserts

Economical
Continued use of existing basic sockets for extensions

Flexible use as an air inlet, air passage and air junction box – some even with rear outlet

Simple assembly
by removing the screens from the basis sockets and screwing on the top sockets

Extra versatility
The top sockets are available in three different models

Protection of lines
The air outlet is directed downwards to avoid bending hoses

Uncomplicated assembly
The screens of the basis sockets serve additionally as drilling templates and spirit level supports.

Model overview:



Model	Art. no.	Outlets	Thread
Socket Box 2x1/2	2813002580	2	1/2"
Socket Box 3x1/2	2813002581	3	1/2"
Socket Box 4x1/2	2813002582	4	1/2"
Socket Box 6x1/2	2813002583	6	1/2"
Socket Box Alu 4x3/4 - 1/2	2813002505	4/1	1" / 1/2"
Socket Box Top 2x1/2	2813002680	2	1/2"
Socket Box Top 3x1/2	2813002681	3	1/2"
Socket Box Top 4x1/2	2813002682	4	1/2"

Five basis sockets with two to six air outlets can be combined with three top sockets with two to four outlets.

If one basis socket is initially sufficient, the screen included in the delivery is clipped onto it. If your socket requirements increase, the system can be extended at any time by adding a top socket without having to disassemble the basis socket.

Further pipe sockets can be connected without any problem at the side via a short pipeline or a double nipple. If an outlet is no longer needed, simply lock it with a locking screw.

Midi System for restricted spatial conditions. With TÜV certificate.

Midi pipe sockets

Assemble the pipe sockets exactly as you need them.

Basic sockets are available for each system. These can then be individually fitted with the required outflows and elements.

This section explains the designation of the inflows and outflows for the Midi pipe sockets:



Socket Box Mini 3/8 - 1/2



Socket Box Mini 2x3/8 - 1/2

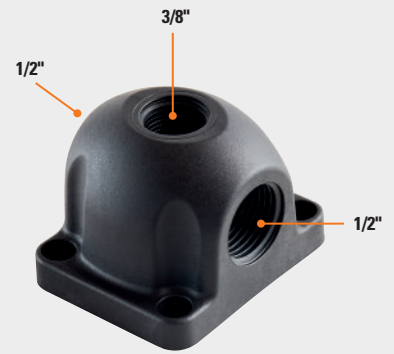

Socket Box Mini 3/8 - 2x1/2

Midi pipe sockets



- Extremely versatile, with input blocks, through blocks and dead-end distribution blocks

▶ For wall and ceiling mounting

▶ Max. operating pressure:
16 bar at -20 °C to ≤ +50 °C

	Designation	Model	Art. no.
	Midi dead-end distribution block	Socket Box Mini 3/8 - 1/2	2813002700
		Socket Box Mini 2x3/8 - 1/2	2813002701
		Socket Box Mini 3/8 - 2x1/2	2813002702



Pipe sockets

Basic pipe sockets

- Basic sockets with integrated plug connectors for simple connection of the pipeline

▶	For wall and ceiling mounting
▶	Including removable screen, which can be used as a drilling template
▶	Max. operating pressure: 16 bar at -20 °C to ≤ +50 °C





Model	Art. no.	Designation	
Socket Box 2x1/2	2813002580	Basic pipe socket G1/2" dimensions without screen LxWxH: 85x85x45 mm, with screen 48 mm high	
Socket Box 3x1/2	2813002581		
Socket Box 4x1/2	2813002582		
Socket Box 6x1/2	2813002583		
Socket Box Alu 4x3/4 – 1/2	2813002505	Basic pipe socket G1" Dimensions LxWxH: 90x90x53 mm	

Top pipe sockets

- Exclusively for fitting to a Basic socket

▶	Top socket including fastening material and sealing
▶	Max. operating pressure: 16 bar at -20 °C to ≤ +50 °C



Model	Art. no.	Designation	
Socket Box Top 2x1/2	2813002680	Pipe socket Top G1/2"	
Socket Box Top 3x1/2	2813002681		
Socket Box Top 4x1/2	2813002682		
			

Hoses and workshop equipment

For a perfectly organised workplace



For private use and professional workshop applications – hard-wearing fabric hoses, flexible Super-Flex hoses or durable polyurethane hoses for every application. For optimal workplace organisation and ergonomic work – hose rewinders, power and air supply units and tractions.

Air hoses

PVC hose with fabric inlay

- Particularly resistant against compressed air containing oil

▶ Max. operating pressure 15 bar at 20 °C

Model	Art. no.	With quick-action coupling and plug nipple	Max. pressure (bar)	Outer dia. (mm)	Inside dia. (mm)	Length (m)
H PVC-QRC-E-15bar 11-6/5m	2813930000	EURO profile	15	11	6	5
H PVC-QRC-U-15bar 11-6/5m	2813930005	UNIVERSAL profile	15	11	6	5
H PVC-QRC-E-15bar 11-6/10m	2813930001	EURO profile	15	11	6	10
H PVC-QRC-U-15bar 11-6/10m	2813930006	UNIVERSAL profile	15	11	6	10
H PVC-15bar 11-6/25m	2813930015		15	11	6	25
H PVC-15bar 11-6/50m	2813930016		15	11	6	50
H PVC-QRC-E-15bar 15-9/5m	2813930002	EURO profile	15	15	9	5
H PVC-QRC-U-15bar 15-9/5m	2813930007	UNIVERSAL profile	15	15	9	5
H PVC-QRC-E-15bar 15-9/10m	2813930003	EURO profile	15	15	9	10
H PVC-QRC-U-15bar 15-9/10m	2813930008	UNIVERSAL profile	15	15	9	10
H PVC-15bar 15-9/25m	2813930017		15	15	9	25
H PVC-15bar 15-9/50m	2813930018		15	15	9	50
H PVC-QRC-E-15bar 18-13/10m	2813930004	EURO profile	15	18	13	10
H PVC-QRC-U-15bar 18-13/10m	2813930009	UNIVERSAL profile	15	18	13	10
H PVC-15bar 18-13/25m	2813930019		15	18	13	25
H PVC-15bar 18-13/50m	2813930020		15	18	13	50
H PVC-QRC-E-OR-15bar 15-9/10m	2813930010	EURO profile	15	15	9	10
H PVC-OR-15bar 15-9/25m	2813930021		15	15	9	25



Fig. 2813930003



Fig. 2813930010 „oil-resistant“

Super-Flex hose

- Reinforced external material for greater resistance to ageing and protection against compressed air containing oil
- Extremely flexible, even at low temperatures

▶ PVC hose with fabric inlay

▶ Max. operating pressure 15 bar at 20 °C

Model	Art. no.	With quick-action coupling and plug nipple	Max. pressure (bar)	Outer dia. (mm)	Inside dia. (mm)	Length (m)
H PVC-QRC-E-SF-15bar 11-6/5m	2813930011	EURO profile	15	11	6,3	5
H PVC-QRC-E-SF-15bar 11-6/10m	2813930012	EURO profile	15	11	6,3	10
H PVC-SF-15bar 11-6/25m	2813930022		15	11	6,3	25
H PVC-SF-15bar 11-6/50m	2813930023		15	11	6,3	50
H PVC-QRC-E-SF-15bar 15-10/5m	2813930013	EURO profile	15	15,5	10	5
H PVC-QRC-E-SF-15bar 15-10/10m	2813930014	EURO profile	15	15,5	10	10
H PVC-SF-15bar 15-10/25m	2813930024		15	15,5	10	25
H PVC-SF-15bar 15-10/50m	2813930025		15	15,5	10	50
H PVC-SF-15bar 19-13/25m	2813930026		15	19	12,7	25
H PVC-SF-15bar 19-13/50m	2813930027		15	19	12,7	50
H PVC-SF-15bar 27-19/25m	2813930028		15	27	19	25
H PVC-SF-15bar 27-19/50m	2813930029		15	27	19	50



Fig. 2813930014



Fig. 2813930023

High-pressure hose version

- High-pressure version for pressure up to 40 bar
- Particularly suitable for connecting pneumatic tools outdoors
- Extremely flexible, even at low temperatures
- For temperature range from -15 °C to +60 °C

▶ PVC hose with reinforced polyester threads, smooth hose core and UV-resistant outer lining

▶ Max. operating pressure 40 bar at 20 °C

Model	Art. no.	Max. pressure (bar)	Outer dia. (mm)	Inside dia. (mm)	Length (m)
H PVC-SF-40bar 16-9/50m	2813930030	40	16	9	50
H PVC-SF-40bar 21-13/50m	2813930031	40	21	13	50



Polyamide spiral hose

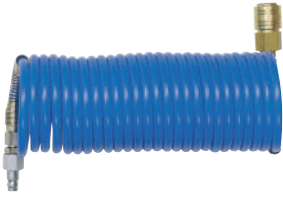

- With rotary quick-action coupling (only QRC) and plug nipple, ready for immediate use
- Bend protection at the spiral hose ends for an extended service life and constant air flow
- Particularly suitable for tractions due to high reset force

▶ Connections with swivel joints (except 2813940000)

Model	Art. no.	With quick-action coupling and plug nipple	Max. pressure (bar)	Outer dia. (mm)	Inside dia. (mm)	Working length (m)	Stretched length (m)
SH PA-QRC-E-8bar 8-6/5m	2813940000	EURO profile	8	8	6	2,5	5
SH PA-QRC-E-8bar 8-6/7,5m	2813940001	EURO profile	8	8	6	4	7,5
SH PA-QRC-E-8bar 8-6/15m	2813940002	EURO profile	8	8	6	8	15
SH PA-QRC-U-8bar 8-6/5m	2813940004	UNIVERSAL profile	8	8	6	2,5	5
SH PA-QRC-U-8bar 8-6/10m	2813940005	UNIVERSAL profile	8	8	6	6	7,5
SH PA-QRC-U-8bar 8-6/15m	2813940006	UNIVERSAL profile	8	8	6	8	15
SH PA-BJ-8bar 8-6/5m	2813940007	BAYONET profile	8	8	6	2,5	5
SH PA-BJ-8bar 8-6/10m	2813940008	BAYONET profile	8	8	6	6	7,5
SH PA-BJ-8bar 8-6/15m	2813940009	BAYONET profile	8	8	6	8	15
SH PA-QRC-E-8bar 10-8/10m	2813940003	EURO profile	8	10	8	6	10

Polyurethane spiral hose



- With rotary quick-action coupling (only SSL-5K) and plug nipple, ready for immediate use
- Bend protection at the spiral hose ends for an extended service life and constant air flow
- Small winding diameter saves space
- Particularly abrasion-resistant and very resilient
- No remaining cross-section reductions upon bending

▶ Connections with swivel joints

Model	Art. no.	With quick-action coupling and plug nipple	Max. pressure (bar)	Outer dia. (mm)	Inside dia. (mm)	Working length (m)	Stretched length (m)
SH PUR-QRC-E-8bar 10-6,5/6m	2813940010	EURO profile	8	10	6,5	4,8	6
SH PUR-QRC-E-8bar 10-6,5/7,5m	2813940011	EURO profile	8	10	6,5	6	7,5
SH PUR-8bar 10-6,5/7,5m	2813940014		8	10	6,5	6	7,5
SH PUR-QRC-E-8bar 12-8/6m	2813940012	EURO profile	8	12	8	4,8	6
SH PUR-QRC-E-8bar 12-8/7,5m	2813940013	EURO profile	8	12	8	6	7,5
SH PUR-8bar 12-8/7,5m	2813940015		8	12	8	6	7,5
SH PUR-8bar 16-10/5m	2813940016		8	16	10	2,5	5
SH PUR-8bar 16-10/10m	2813940017		8	16	10	6	10

Workshop equipment

Traction

- For all types of portable devices and tools
- Fully fitted with safety cable, terminal block and snap hook
- High degree of flexibility because the spring tension on the housing can be used to set and adjust the required load capacity

▶	Compact, with robust aluminium housing
▶	Rubber buffer at the end



Model	Art. no.	Carrying power (kg)	Stroke length (m)	Weight (kg)
EQ SST-0,4-1,0kg	2813960000	1	1.6	0.63
EQ SST-1,0-2,0kg	2813960001	2	1.6	0.67
EQ SST-2,0-3,0kg	2813960002	3	1.6	0.79
EQ SST-2,0-4,0kg	2813960003	4	2.5	2.85
EQ SST-4,0-6,0kg	2813960004	6	2.5	3
EQ SST-6,0-8,0kg	2813960005	8	2.5	3.1

Hose rewriter, automatic

- With durable rolling mechanism for daily use in trade and the industry
- Fully fitted with quick-action coupling and long connection hose with plug nipple, ready to connect
- Flexible use with large swivel range
- Wall mounting

▶	Abrasion-resistant, flexible air hose with antikink spring and hose locking device
▶	Locking function can be deactivated
▶	Plastic housing



Model	Art. no.	Max. pressure (bar)	Outer dia. (mm)	Inside dia. (mm)	Extendable length (m)	Weight (kg)
HR PVC-QRC-U-A-15bar 12-8/10m	2813950004	15	12	8	10	4
HR PVC-QRC-U-A-15bar 12-8/15m	2813950005	15	12	8	15	7.3
HR PVC-QRC-U-A-15bar 14-10/15m	2813950006	15	14	10	15	8.8
HR PVC-QRC-U-A-15bar 18-13/15m	2813950007	15	17.5	12.5	15	10.5

Accessories for hose rewriter, automatic

- More safety by slowing down the rewinding hose

Model	Art. no.	Accessories
HR B 18-13/15	2813950008	for HR PVC-QRC-U-A-15bar 18-13/15m (2813950007)



Hose rewriter, automatic



- Fully fitted with quick-action coupling and long connection hose with plug nipple, ready to connect
- Flexible use with large swivel range greater than 180°
- For wall and ceiling mounting

- ▶ With robust metal housing
- ▶ With protected quick-action coupling
- ▶ Abrasion-resistant, flexible air hose with antikink spring and hose locking device

Model	Art. no.	Max. pressure (bar)	Outer dia. (mm)	Inside dia. (mm)	Extendable length (m)	Weight (kg)
HR PVC-QRC-U-A-15bar 12-8/9m	2813950002	15	12	8	9	5
HR PVC-QRC-U-A-15bar 12-8/15m	2813950003	15	12	8	15	6

Hose rewriter, manual



- Axial connection - this way the hose can also be wound and unwound during operation
- Flexible PVC hose with fabric inlay

- ▶ Shock-resistant plastic housing
- ▶ Large work radius thanks to 20 m hose

Model	Art. no.	Max. pressure (bar)	Outer dia. (mm)	Inside dia. (mm)	Extendable length (m)	Weight (kg)
HR PVC-QRC-U-M-15bar 15-9/20m	2813950000	15	15	9	20	3.9

Workshop equipment

Power and air supply unit

- Galvanised suspension chain relieves the connection hose and connection cable
- Electric safety device - the thermal fuse automatically switches off in the event of overheating
- Robust housing - splashproof and dustproof acc. to IP 44



- ▶ Safety couplings prevent the air hose from ejecting during release
- ▶ Connection option - every 3 shockproof sockets on front and back

Model	Art. no.	Schuko power outlets 16A/230V (pc.)	Cekon power outlets 16A/400V (pc.)	Compressed air connections	Suspension chain length (m)	Connection hose internal diameter (mm)	Weight (kg)
EQ EB-PVC-2QRC-SF-15bar-6*230V	2813960009	6		2	2	9	2.9
EQ EB-PVC-2QRC-SF-15bar-6*230V-1*400V	2813960010	6	1	2	2	9	2.9

Power and air supply unit

- Galvanised suspension chain relieves the connection hose and connection cable
- Robust housing - splashproof and dustproof acc. to IP 44
- Ready to connect thanks to connected electric cable with plug and air hose (length: 3 m) with plug nipple



- ▶ Safety couplings prevent the air hose from ejecting during release
- ▶ Connection option - every 3 shockproof sockets

Model	Art. no.	Schuko power outlets 16A/230V (pc.)	Compressed air connections	Suspension chain length (m)	Connection hose internal diameter (mm)	Weight (kg)
EQ EB-PVC-QRC-SF-12bar-3*230V	2813960011	3	1	3	9	2.0

Connecting & joining technology

User-friendly and safe



For all connections on tools, hoses and machines –
from the simple nipple to the more
complex safety quick-action coupling.

Connecting and joining technology

Steel safety quick-release couplings

- Safe working because the hose is not ejected when disconnected (whiplash effect), DIN EN ISO 4414 and DIN EN 983
- Hardened galvanised steel for an extended service life
- Low coupling force for easy coupling

▶	Eurostandard profile with nominal width of 7.6 for extremely high air flow rate
▶	Max. operating pressure 16 bar
▶	Free of silicone



Model	Art. no.	Packaging unit (pc.)	Designation	
C QRC-SF-E-1/4"m	2813910018	1	Safety quick-release couplings with external thread	
C QRC-SF-E-3/8"m	2813910019	1		
C QRC-SF-E-1/2"m	2813910020	1		
C QRC-SF-E-1/4"f	2813910021	1	Safety quick-release couplings with internal thread	
C QRC-SF-E-3/8"f	2813910022	1		
C QRC-SF-E-1/2"f	2813910023	1		
C QRC-SF-E-6mm	2813910024	1	Safety quick-release couplings hose nozzle	
C QRC-SF-E-9mm	2813910025	1		
C QRC-SF-E-13mm	2813910026	1		

Minimum order quantity for specialist dealers: 5 units

Tip >>> Only use steel quick-release couplings in conjunction with hardened steel plug nipples

Steel quick-release couplings with external thread

- Hardened galvanised steel for an extended service life
- Low coupling force for easy coupling

▶	Eurostandard profile with nominal width of 7.6 for extremely high air flow rate
▶	Max. operating pressure 16 bar
▶	Free of silicone



Model	Art. no.	Packaging unit (pc.)	Designation	
C QRC-S-E-1/4"m	2813910009	1	Quick-release couplings with external thread	
C QRC-S-E-3/8"m	2813910010	1		
C QRC-S-E-1/2"m	2813910011	1		
C QRC-S-E-1/4"f	2813910012	1	Quick-release couplings with internal thread	
C QRC-S-E-3/8"f	2813910013	1		
C QRC-S-E-1/2"f	2813910014	1		
C QRC-S-E-6mm	2813910015	1	Quick-release couplings with hose nozzle	
C QRC-S-E-9mm	2813910016	1		
C QRC-S-E-13mm	2813910017	1		

Minimum order quantity for specialist dealers: 5 units

Tip >>> Only use steel quick-release couplings in conjunction with hardened steel plug nipples

Steel plug nipple



- Specially designed for use with steel quick-release couplings
- Hardened galvanised steel for an extended service life

▶ Eurostandard profile with nominal width of 7.6 for extremely high air flow rate

	Designation	Model	Art. no.	Packaging unit (pc.)
	Steel plug nipple with external thread	C PN-S-E-1/4"m	2813910000	1
		C PN-S-E-3/8"m	2813910001	1
		C PN-S-E-1/2"m	2813910002	1
	Steel plug nipple with internal thread	C PN-S-E-1/4"f	2813910003	1
		C PN-S-E-3/8"f	2813910004	1
		C PN-S-E-1/2"f	2813910005	1
	Steel plug nipple with hose nozzle	C PN-S-E-6mm	2813910006	1
		C PN-S-E-9mm	2813910007	1
		C PN-S-E-13mm	2813910008	1

Minimum order quantity for specialist dealers: 5 units

Brass quick-release couplings Euro profile



▶ European standard profile

▶ NW 7.2

▶ Material: Brass

	Designation	Model	Art. no.	Packaging unit (pc.)
	Quick-release couplings with external thread	C QRC-E-1/4"m	2813910027	1
		C QRC-E-3/8"m	2813910028	1
		C QRC-E-1/2"m	2813910029	1
	Quick-release couplings with internal thread	C QRC-E-1/4"f	2813910030	1
		C QRC-E-3/8"f	2813910031	1
		C QRC-E-1/2"f	2813910032	1
	Quick-release couplings with hose nozzle	C QRC-E-6mm	2813910033	1
		C QRC-E-9mm	2813910034	1
		C QRC-E-13mm	2813910035	1
	Distributor with quick-release couplings	C 2QRC-E-3/8"f	2813910036	1
		C 3QRC-E-3/8"f	2813910037	1

Connecting and joining technology

Brass quick-release couplings Universal profile

▶	European standard profile
▶	NW 7.2
▶	Material: Brass



Model	Art. no.	Packaging unit (pc.)	Designation	
C QRC-U-1/4"m	2813910084	1	Quick-release couplings with external thread	
C QRC-U-3/8"m	2813910085	1		
C QRC-U-1/2"m	2813910086	1		
C QRC-U-1/4"f	2813910087	1	Quick-release couplings with internal thread	
C QRC-U-3/8"f	2813910088	1		
C QRC-U-1/2"f	2813910089	1		
C QRC-U-6mm	2813910090	1	Quick-release couplings with hose nozzle	
C QRC-U-9mm	2813910091	1		
C QRC-U-13mm	2813910092	1		

Brass plug nipples

▶	European standard profile
▶	NW 7.2
▶	Material: Brass



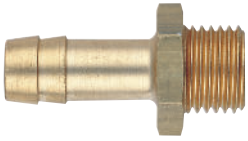

Model	Art. no.	Packaging unit (pc.)	Designation	
C PN-E-1/4"m	2813910041	1	Plug nipple with external thread	
C PN-E-3/8"m	2813910042	1		
C PN-E-1/2"m	2813910043	1		
C PN-E-1/4"f	2813910044	1	Plug nipple with internal thread	
C PN-E-3/8"f	2813910045	1		
C PN-E-1/2"f	2813910046	1		
C PN-E-6mm	2813910038	1	Plug nipple with hose nozzle	
C PN-E-9mm	2813910039	1		
C PN-E-13mm	2813910040	1		

Hoze nozzles

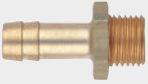

▶ European standard profile

▶ Material: Brass

	Designation	Model	Art. no.	Packaging unit (pc.)
 Hose nozzle with external thread		C HN-U-1/4"m x 6mm	2813910054	1
		C HN-U-1/4"m x 9mm	2813910055	1
		C HN-U-3/8"m x 6mm	2813910056	1
		C HN-U-3/8"m x 9mm	2813910057	1
		C HN-U-3/8"m x 13mm	2813910058	1
		C HN-U-1/2"m x 6mm	2813910059	1
		C HN-U-1/2"m x 9mm	2813910060	1
		C HN-U-1/2"m x 13mm	2813910061	1
 Hose nozzle with internal thread		C HN-U-1/4"f x 6mm	2813910062	1
		C HN-U-1/4"f x 9mm	2813910063	1
		C HN-U-3/8"f x 6mm	2813910064	1
		C HN-U-3/8"f x 9mm	2813910065	1
		C HN-U-1/2"f x 9mm	2813910066	1
		C HN-U-1/2"f x 13mm	2813910067	1
 Hose coupling		C HOC-U-6mm	2813910068	1
		C HOC-U-9mm	2813910069	1

Hose clamps



- Steel
- Galvanised and polished with 2 profiled lugs
- Range: 7 mm

Model	Art. no.	Packaging unit (pc.)
C HC-U-11-13mm	2813910047	1
C HC-U-13-15mm	2813910048	1
C HC-U-15-18mm	2813910049	1

Screw clamps



- Steel, polished and galvanised
- Range: 9 mm
- Screw thread with Phillips screw AF 7 mm

Model	Art. no.	Packaging unit (pc.)
C SC-U-10-16mm	2813910050	1
C SC-U-12-20mm	2813910051	1
C SC-U-16-25mm	2813910052	1
C SC-U-20-32mm	2813910053	1

Connecting and joining technology

Double nipple

Model	Art. no.	Packaging unit (pc.)	Material	Thread	Designation	
C DN-U-1/4"m x 1/8"m	2813910070	1	Galvanised steel	With internal cone	Double nipple	
C DN-U-1/4"m x 1/4"m	2813910071	1	Galvanised steel	With internal cone		
C DN-U-3/8"m x 3/8"m	2813910073	1	Galvanised steel	With internal cone		
C DN-U-1/2"m x 1/2"m	2813910075	1	Galvanised steel	With internal cone		
C DN-U-3/8"m x 1/4"m	2813910072	1	Galvanised steel	With internal cone		
C DN-U-1/2"m x 3/8"m	2813910074	1	Galvanised steel	With internal cone		

Reduction fittings

Model	Art. no.	Packaging unit (pc.)	Material	Thread	Designation	
C RE-U-1/4"m x 1/8"f	2813910076	1	Brass	With external and internal thread	Reduction fitting	
C RE-U-3/8"m x 1/4"f	2813910077	1	Brass	With external and internal thread		
C RE-U-1/2"m x 3/8"f	2813910078	1	Brass	With external and internal thread		

Reducing nipple

Model	Art. no.	Packaging unit (pc.)	Material	Thread	Designation	
C RN-U-1/4"m x 3/8"f	2813910079	1	Brass	With external and internal thread	Reducing nipple	
C RN-U-3/8"m x 1/2"f	2813910080	1	Brass	With external and internal thread		

Sleeves

Model	Art. no.	Packaging unit (pc.)	Material	Designation	
C MU-1/4"f	2813910081	1	Brass	Sleeve	
C MU-3/8"f	2813910082	1	Brass		
C MU-1/2"f	2813910083	1	Brass		

Maintenance units

Excellent air quality for every application



Achieve maximum compressed air quality and outstanding working results with our filters and maintenance units – from prefilters and microfilters through to activated carbon filters.

Maintenance units

Pressure reducer

- Pressure regulator with piston for high operational reliability
- High stability of adjusting pressure, even if the input pressure or the flow rate changes
- Assembly independent of flow direction thanks to double-sided connection option for pressure gauge

▶	With lockable adjustment button
▶	Regulation range 0-12 bar
▶	Standard features include: pressure gauge



Model	Art. no.	Flow rate (l/min)	Connecting thread	Connection for pressure gauge	Dimensions (WxDxH)
FRL PR-1/4" f	2813920000	700	G 1/4"i	G 1/8"i	42x42x94
FRL PR-1/4" f NPT	2813920033	700	G 1/4"i	G 1/8"i	42x42x94
FRL PR-3/8" f	2813920001	2,500	G 3/8"i	G 1/8"i	60x60x130
FRL PR-3/8" f NPT	2813920034	2,500	G 3/8"i	G 1/8"i	60x60x130
FRL PR-1/2" f	2813920002	2,500	G 1/2"i	G 1/8"i	60x60x130
FRL PR-1/2" f NPT	2813920035	2,500	G 1/2"i	G 1/8"i	60x60x130
FRL PR-3/4" f	2813920003	5,600	G 3/4"i	G 1/4"i	80x80x184
FRL PR-3/4" f NPT	2813920004	5,600	G 3/4"i	G 1/4"i	80x80x184
FRL PR-1" f	2813920005	5,600	G 1"i	G 1/4"i	80x80x184
FRL PR-1" f NPT	2813920006	5,600	G 1"i	G 1/4"i	80x80x184

Water separator with filter

- Centrifugal acceleration of compressed air for efficient separation of dirt particles and condensate
- Filtering function upstream of the pressure reducer

▶	Two-stage mechanical filter with 20 µm
▶	Semi-automatic drainage



Model	Art. no.	Connecting thread	Condensate tank volume (cm³)	Dimensions (WxDxH)
FRL WS-1/4" f	2813920007	G 1/4"i	10	42x42x142
FRL WS-1/4" f NPT	2813920036	G 1/4"i	10	42x42x142
FRL WS-3/8" f	2813920008	G 3/8"i	45	60x60x180
FRL WS-3/8" f NPT	2813920037	G 3/8"i	45	60x60x180
FRL WS-1/2" f	2813920009	G 1/2"i	45	60x60x180
FRL WS-1/2" f NPT	2813920038	G 1/2"i	45	60x60x180
FRL WS-3/4" f	2813920010	G 3/4"i	170	80x80x235
FRL WS-3/4" f NPT	2813920011	G 3/4"i	170	80x80x235
FRL WS-1" f	2813920012	G 1"i	170	80x80x235
FRL WS-1" f NPT	2813920013	G 1"i	170	80x80x235

Filter pressure reducer



- Combines the technical benefits of the pressure reducer and the water separator with filter in one compact unit
- Pressure regulator with piston for high operational reliability
- Assembly independent of flow direction thanks to double-sided connection option for pressure gauge

▶	With lockable adjustment button
▶	Regulation range 0-12 bar
▶	Standard features include: pressure gauge and 20 µm filter element

Model	Art. no.	Flow rate (l/min)	Connection thread	Condensate tank volume (cm³)	Dimensions (WxDxH)
FRL FPR-1/4" f	2813920014	700	G 1/4" i	10	42x42x190
FRL FPR-1/4" f NPT	2813920039	700	G 1/4" i	10	42x42x190
FRL FPR-3/8" f	2813920015	2,500	G 3/8" i	45	60x60x245
FRL FPR-3/8" f NPT	2813920040	2,500	G 3/8" i	45	60x60x245
FRL FPR-1/2" f	2813920016	2,500	G 1/2" i	45	60x60x245
FRL FPR-1/2" f NPT	2813920041	2,500	G 1/2" i	45	60x60x245
FRL FPR-3/4" f	2813920017	5,600	G 3/4" i	170	80x80x332
FRL FPR-3/4" f NPT	2813920018	5,600	G 3/4" i	170	80x80x332
FRL FPR-1" f	2813920019	5,600	G 1" i	170	80x80x332
FRL FPR-1" f NPT	2813920020	5,600	G 1" i	170	80x80x332

Mist oiler



- Regular oil flow for efficient supply to tools
- Proportional adjustment of the oil supply to the air flow rate for optimal lubrication possible, even at low pressures and low air flow rates
- Oil purification downstream of the filter pressure reducer

Model	Art. no.	Connecting thread	Oil reservoir volume (cm³)	Dimensions (WxDxH)
FRL MO-1/4" f	2813920021	G 1/4" i	50	42x42x156
FRL MO-1/4" f NPT	2813920042	G 1/4" i	50	42x42x156
FRL MO-3/8" f	2813920022	G 3/8" i	150	60x60x195
FRL MO-3/8" f NPT	2813920043	G 3/8" i	150	60x60x195
FRL MO-1/2" f	2813920023	G 1/2" i	150	60x60x195
FRL MO-1/2" f NPT	2813920044	G 1/2" i	150	60x60x195
FRL MO-3/4" f	2813920024	G 3/4" i	379	80x80x260
FRL MO-3/4" f NPT	2813920045	G 3/4" i	379	80x80x260
FRL MO-1" f	2813920025	G 1" i	379	80x80x260
FRL MO-1" f NPT	2813920046	G 1" i	379	80x80x260

Maintenance units

Filter units

- Fully fitted maintenance system consisting of filter pressure reducer and mist oiler (2-way filter unit) or filter water separator, pressure reducer and mist oiler (3-way filter unit) ready for immediate operation
- Pressure regulator with piston for high operational reliability

▶	With lockable adjustment button
▶	Regulation range 0-12 bar
▶	Standard features include: pressure gauge and 20 µm filter element

Model	Art. no.	Flow rate (l/min)	Version	Connecting thread	Dimensions (WxDxH)
FRL FPR-MO-1/4" f	2813920026	700	double	G 1/4"i	84x42x190
FRL FPR-MO-1/4" f NPT	2813920047	700	double	G 1/4"i	84x42x190
FRL FPR-MO-3/8" f	2813920027	2,500	double	G 3/8"i	120x60x245
FRL FPR-MO-3/8" f NPT	2813920048	2,500	double	G 3/8"i	120x60x245
FRL FPR-MO-1/2" f	2813920028	2,500	double	G 1/2"i	120x60x245
FRL FPR-MO-1/2" f NPT	2813920049	2,500	double	G 1/2"i	120x60x245
FRL FPR-MO-3/4" f	2813920029	5,600	double	G 3/4"i	160x80x332
FRL FPR-MO-3/4" f NPT	2813920030	5,600	double	G 3/4"i	160x80x332
FRL FPR-MO-1" f	2813920031	5,600	double	G 1"i	160x80x332
FRL FPR-MO-1" f NPT	2813920032	5,600	double	G 1"i	160x80x332





www.airnet-system.com

We do not accept any liability for errors, printing errors or any changes made to the technical specifications.
All illustrations are non-binding. The content of the catalogue is correct at the time of going to print 11/2019.

FAST / EASY / RELIABLE